

SAFESITE FACILITIES PRODUCT GUIDE

Products
Available
to Hire!

BARRIERS • FENCING • HOARDING • PARKING CONTROL
STREETWORKS • GROUND PROTECTION • CCTV & ALARMS

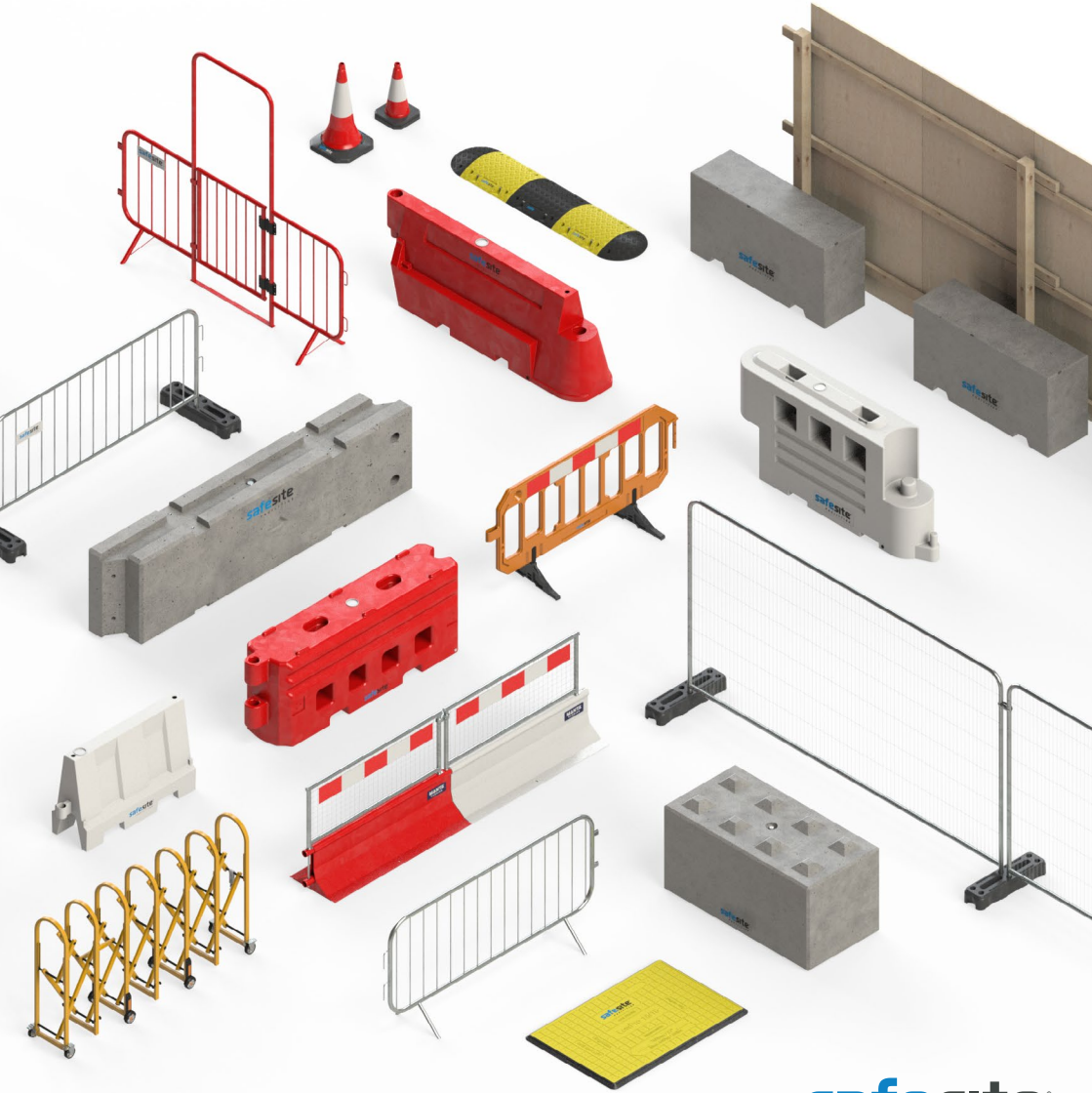

WE ARE SAFESITE.

SafeSite Facilities was **established in 2009** in a single office in West Sussex and now has sites across the length and breadth of the UK.

SafeSite Facilities are known best for our spectrum of products and services for the **construction industry** but also serve the **aviation, rail, road, entertainment, and event sectors**.

The business was co-founded by Managing Director, Michael Knibbs who is passionate about consistently exceeding customer expectations and delivering high levels of customer satisfaction.

Products Available to Hire!



CONTENTS

WATER FILLED BARRIERS	09-25
CONCRETE BARRIERS	27-31
PEDESTRIAN BARRIERS	33-38
STREETWORKS	41-64
PARKING CONTROL	67-70
GROUND PROTECTION	73-80
FENCING & HOARDING	83-109
BALLAST & STABILISATION	111-117
CCTV & ALARMS	119-125

Key:  Crash Tested  Wind Tested  Any Colour

Disclaimer: All product information is correct at time of publishing – May 2024

WELCOME TO OUR PRODUCT GUIDE

We are pleased to present our new product guide which is a non-exclusive list of all our products and services.

You may be surprised to learn how customisable most of our products are, with different colours and sizes commonly available. If what you need is not listed here, we can source it.

Our SafeSite promise guarantees you high standards of service, nationwide coverage, hassle and cost-free quotes, and the most competitive prices the industry has to offer.

All our sales personnel are experienced in all things safety and security. They can advise on the appropriate solution by task and location and organise delivery and installation anywhere in the UK.



Michael Knibbs -
Founder of SafeSite Facilities





DID YOU KNOW?

You can hire all the elements of a barrier system you require, instead of buying the products outright

If you have a short-term project or restricted budget, hiring a system can offer several benefits:



Cost effectiveness

No upfront costs and pay only for the time you use our products.



Zero storage

Save on storage space and costs.

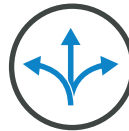

Flexibility

If your project finishes early, we can collect the products and your fee stops.



Sustainability

Hire what you need for the time you need and save on transport and waste.

We will always offer the best price on our products and services. Not only do we supply, deliver, and install our products anywhere in the UK but also buyback any product. If you've completed your project and can't take your barriers with you, we'll buy them from you.

We offer sale, hire and buyback on all our products. Contact our sales team for more information.

WATER FILLED BARRIER FENCING & HOARDING



MESH &
HOARDING
GATES OPTIONS
AVAILABLE

DID YOU KNOW?

A lot of our water filled barriers are compatible with mesh or hoarding. Each individual water filled barrier has it's own range of mesh fencing and hoarding, all of which is made from steel and powder-coated white.

This varies from barrier to barrier, for any queries on our fencing range for our water filled barriers, get in contact with our sales team. We're always happy to help!

We offer a comprehensive range of water filled barriers which can be used with mesh fence panels, hoarding panels and gates. The systems are perfect for situations where it's not possible to break ground such as heritage sites, airports, railways, highways, events, and construction sites. They offer a semi-permanent, secure, and safe solution that can be used to either fully or partially obscure a site.

Whilst we stock white and red versions of the barriers as standard. We custom manufacture water filled barriers in **any RAL colour**.

Key:  Crash Tested  Wind Tested  Any Colour



WT

Colour Options: ● ○

A versatile and heavy duty barrier which can rotate 90 degrees to navigate bends and can be used with mesh and gates.

Description	Size (mm)	Weight (kg)	Weight Filled (kg)
WFS150000 – Bison Barrier	H1000 x W2000 x D400	35	400
WFS150020 – Bison Mesh Fence Panel	H1050 x W1938 x D38	8	-
WFS150030 – Bison Hoarding Panel	H1050 x W1938 x D40	17.5	-
WFS150060 – Bison Hoarding Infill Panel	H960 x W140 x D1.2	1	-

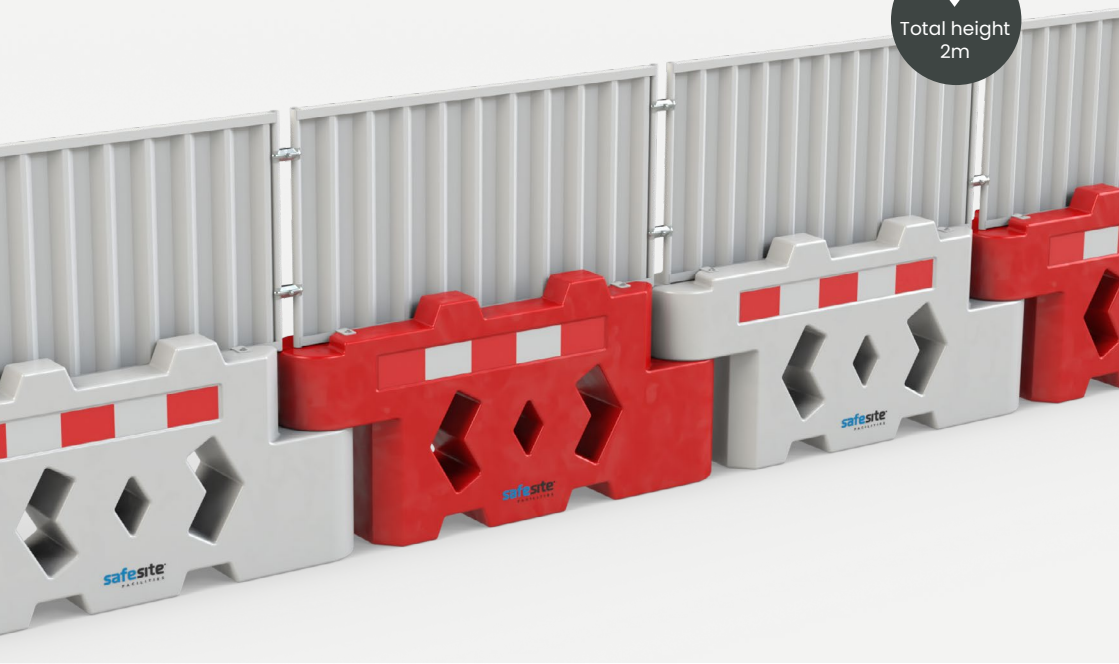
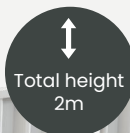
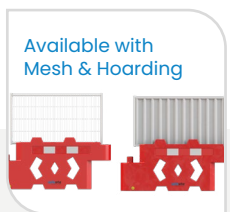

Colour Options: ● ○ ●

This water filled barrier can be installed in straight lines and around bends. It's also compatible with mesh fence, hoarding and gates.

WT

Description	Size (mm)	Weight (kg)	Weight Filled (kg)
WFS150700 – RB2000 Barrier	H1000 x W1680 x D400	35	400
WFS150720 – RB2000 End Start	H1000 x W550 x D400	5	-
WFS150730 – RB2000 End Stop	H1000 x W550 x D400	5	-
WFS150750 – RB2000 Mesh Fence Panel	H1120 x W1500 x D40	12	-
WFS150740 – RB2000 Hoarding Panel	H1120 x W1500 x D40	21	-
WFS150800 – RB2000 Hoarding Infill Panel	H1150 x W150 x D1.2	1.5	-

Colour Options:

The Bison 800 measures smaller than the standard Bison but offers all the same features. The Bison 800 is shorter by 200mm yet has the same weight when filled as the Bison.

WT

Description	Size (mm)	Weight (kg)	Weight Filled (kg)
WFS150005 – Bison 800 Barrier	H725 x W2250 x D350	26	400
WFS150020 – Bison 800 Mesh Fence Panel	H1050 x W1938 x D38	8	-
WFS150023 – Bison 800 2m Mesh Fence Panel	H1355 x W1938 x D38	8.5	-
WFS150030 – Bison 800 Std Hoarding Panel	H1050 x W1938 x D38	17.5	-
WFS150060 – Bison 800 Hoarding Infill Panel	H960 x W140 x D1.2	1	-
WFS150035 – Bison 800 2m Hoarding Panel	H1200 x W1938 x D38	21	-
WFS150065 – Bison 800 2m Hoarding Panel Infill Panel	H1225 x W140 x D1.5	2	-



Bison Mini Barrier

Colour Options:

These barriers are a great medium-sized barrier which can be used with mesh to create a 2m high perimeter.

WT

Description	Size (mm)	Weight (kg)	Weight Filled (kg)
WFS150007 – Bison Mini Barrier	H720 x W1160 x D300	9	70
WFS150055 – Bison Mini Mesh Panel	H1340 x W948 x D38	6	-

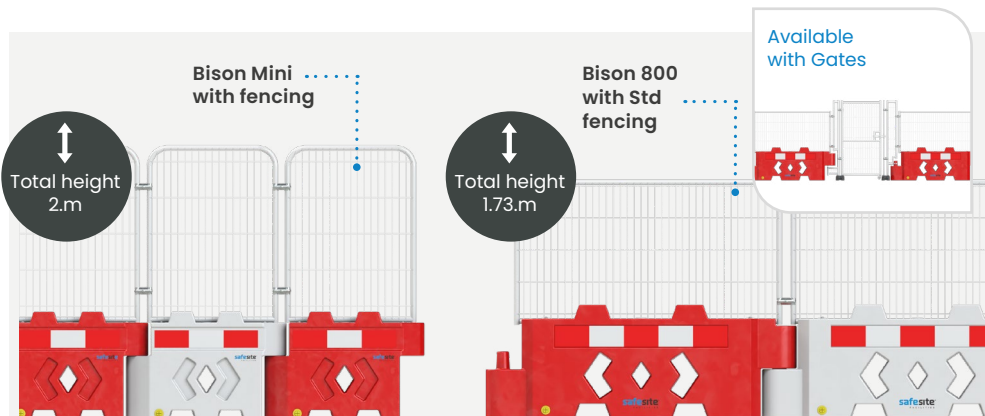

Colour Options:

These are cost-effective, medium-sized barriers which can be used with mesh fences and gates with a total height of 2.15m for your site.

WT

Description	Size (mm)	Weight (kg)	Weight Filled (kg)
WFS151500 – Novus Barrier	H800 x W2000 x D520	25	180
WFS151520 – Novus Barrier Mesh Panel	H1350 x W1908 x D38	8.6	-

WT

CT

 Total height
2.25m

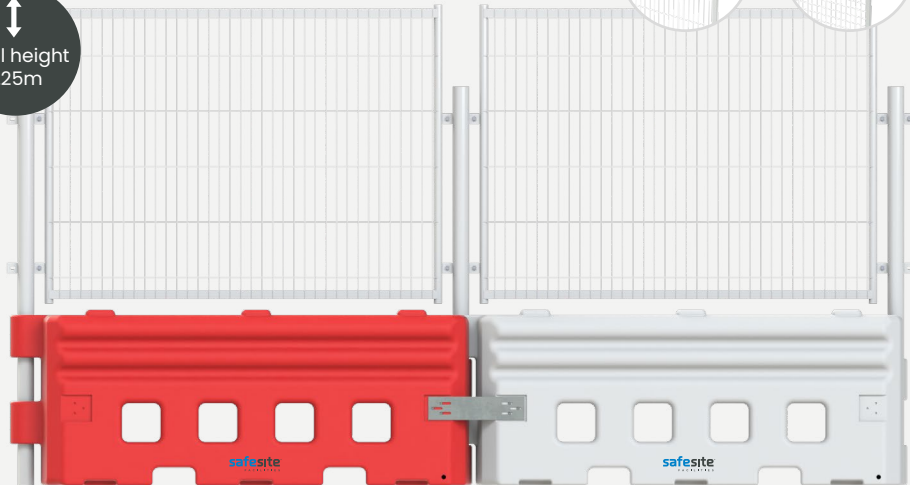
 Anti-Climb Mesh
 Heavy Duty Mesh

 Colour Options: ● ○

These crash tested water filled barriers are an industry favourite for construction sites and highway maintenance. The barriers navigate corners with ease and are compatible with mesh fencing, hoarding panels and gates.

Description	Size (mm)	Weight (kg)	Weight Filled (kg)
RBS160000 – RB22 2m Barrier	H800 x W2000 x D500	60	600
RBS160070 – RB22 End Bracket Female	H800 x W680 x D500	12	167
RBS160100 – RB22 Angle Barrier	H800 x W680 x D500	12	167
RBS160200 – RB22 Side Plate	H100 x W315 x D9	1.7	-
RBS160250 – RB22 Steel Connecting Pin	H800 x D76	4	-
RBS160320 – RB22 Mesh Panel	H1400 x W1852 x D40	8.7	-
RBS160300 – RB22 Hoarding Panel	H1400 x W1852 x D40	25	-
RBS160700 – RB22 Hoarding Infill Panel	H1348 x W274 x D40	5	-

 CRASH
TESTED

*Affix the metal plates to the barriers to adhere to crash test certification.



Colour Options: 

GB2 barriers are known for their large size and compatibility with mesh fences, hoarding and gates. They are easy to assemble and can be used quickly to create a 800mm high border.

WT

Description	Size (mm)	Weight (kg)	Weight Filled (kg)
GBS170000 – GB2 Heavy Duty Barrier	H860 x W2060 x D500	32	350
GBS170100 – GB2 Connection Pin	H830 x W42 x D76	0.6	-
GBS170200 – GB2 Hoarding Panel	H1400 x W1790 x D40	22	-
GBS170450 – GB2 Hoarding Infill Panel	H1505 x D76	8.1	-
GBS170220 – GB2 Mesh Panel	H1400 x W1790 x D38	8.5	-

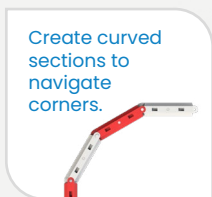

Colour Options: ● ○

The CityWall Barrier is 2-meter water filled hook and eye traffic barrier system that has the capacity of over 270 litres. This is the ideal, solution for improving traffic management in major projects and enhance road safety in urban areas.

Description	Size (mm)	Weight (kg)	Weight Filled (kg)
WFS150240 - CityWall Barrier	H800 x W2295 x D350	21.5	271.5
WFS150220 - Mini Topper	H535 x W1115 x D60	3	-
WFS150230 - Double Top	H1000 x W1115 x D60	4.4	-

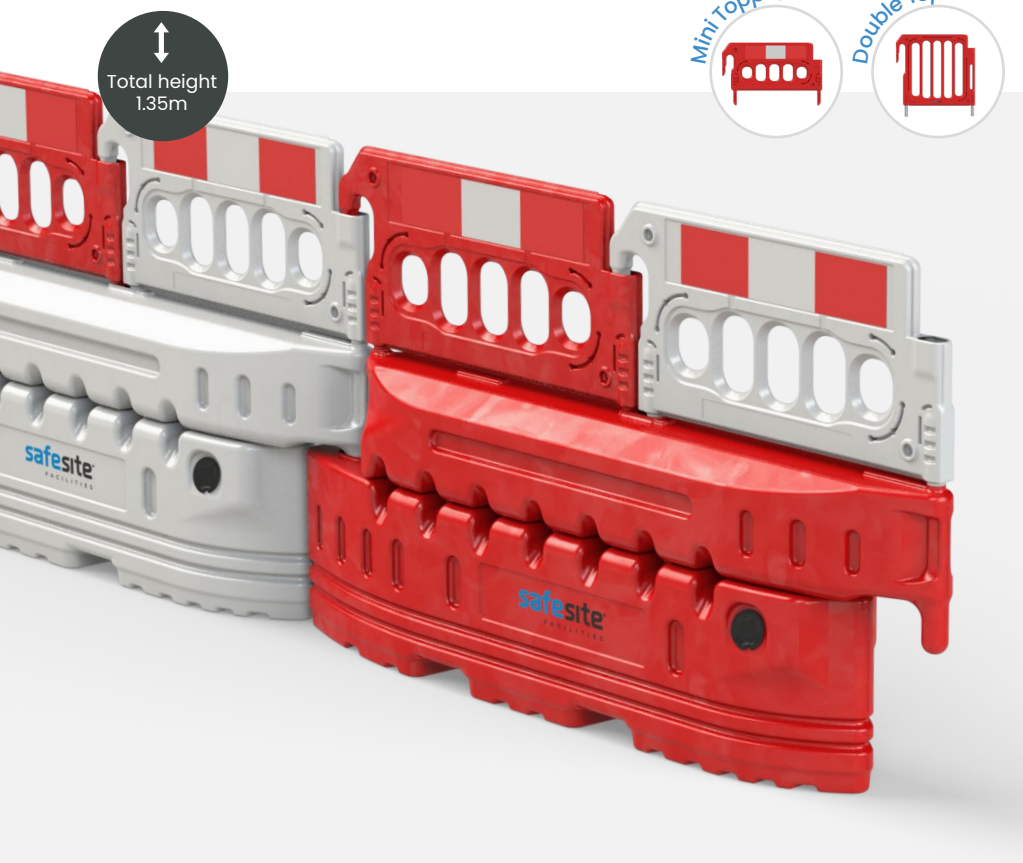

WATER FILLED BARRIERS

Colour Options: ● ○

The Buddha is quick to install and can be easily stacked for transportation. It's easy to create a box shape with the Buddha so it's often used to square off hazardous areas such as excavations.

Description	Size (mm)	Weight (kg)	Weight Filled (kg)
WFS150150 - Buddha Barrier With Reflective Stickers	H800 x W1040 x D280	5.5	27.5
WFS150170 - Buddha Barrier Without Reflective Stickers	H800 x W1040 x D280	5.5	27.5
WFS150200 - Buddha Barrier S-Clip	-	-	-
WFS150210 - Buddha Barrier Mesh Panel	H1040 x W800 x D38	4	-
WFS150220 - Mini Topper	H535 x W1115 x D60	3	-
WFS150230 - Double Top	H1000 x W1115 x D60	4.4	-

These barriers link with a hook and loop system and can be positioned at 60 degree angles. Add extra height with a mini topper or double top panel.

WT

Description	Size (mm)	Weight (kg)	Weight Filled (kg)
WFS151400 - Hog 600 Barrier	H560 x W1130 x D400	5.5	60
WFS150220 - Mini Topper	H535 x W1115 x D60	3	-
WFS150230 - Double Top	H1000 x W1115 x D60	4.4	-

Slot Block Barrier with temporary fencing

Available with Gates

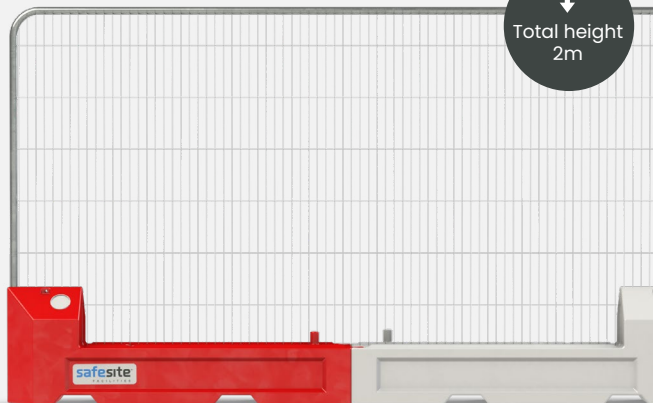
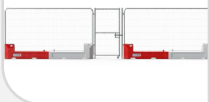

Colour Options: ● ● ● ●

The slot block barrier is a water filled, wind tested solution used when installing temporary mesh fencing to your site.

WT

Description	Size (mm)	Weight (kg)	Weight Filled (kg)
WFS151300 - Slot Block Barrier	H600 x W1750 x D380	14	160

Total height 2.02m

Slots easily together

90° cornering

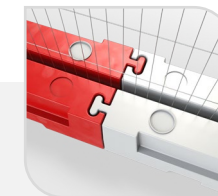

Colour Options: ● ●

Rota Slot bases offer water filled ballast for standard 3.5m temporary fencing, ensuring security and stability in applications like construction, events, and crowd control.

WT

Description	Size (mm)	Weight (kg)	Weight Filled (kg)
WFS151180 - Slot Block Barrier	H300 x W3500 x D400	26	320

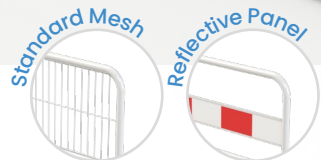

Colour Options: ● ○

Pyramid barriers can be used to box off areas or as perimeter protection with mesh or reflective Chapter 8 panels.

Description	Size (mm)	Weight (kg)	Weight Filled (kg)
WFS150900 – Pyramid Barrier	H560 x W1000 x D400	5	55
WFS150920 – Pyramid Barrier Mesh Panel	H560 x W960 x D38	4	-

Colour Options: ● ○

Euro barriers are a simple system for re-routing traffic flow and are compatible with reflective, mesh panels and post and rail add-ons.

Description	Size (mm)	Weight (kg)	Weight Filled (kg)
WFS150250 – Euro 1 Barrier	H650 x W1000 x D550	10	50
WFS150270 – Euro 1 Mesh Fence Panel	H560 x W960 x D38	18	-
WFS150300 – Euro 2 Barrier	H650 x W2000 x D550	18	110
WFS150320 – Euro 2 Mesh Fence Panel	H560 x W1995 x D38	18	-

WT*

Colour Options: ● ○ ●

These barriers are cost-effective and easy to deploy. Made from UV stabilised polyethylene, they are designed to withstand all weather conditions and interlock neatly to create a solid wall with no gaps.

Description	Size (mm)	Weight (kg)	Weight Filled (kg)
WFS150420 – EVO 500 Barrier	H500 x W1000 x D300	4.6	16
WFS150450 – EVO 1.5m Barrier	H555 x W1500 x D400	10	30
WFS150500 – EVO 55 Barrier	H555 x W1000 x D400	8	28
WFS150920 – EVO 55 / 500 Mesh Panel	H560 x W960 x D38	4	-
WFS150470 – EVO 1.5m Mesh Panel	H560 x W1450 x D38	6	-
WFS150520 – EVO 55/1.5m Angle Barrier	H555 x W430 x D580	4.5	18.5
WFS150535 – EVO 55/1.5m Angle Barrier Mini Mesh Panel	H560 x W960 x D38	4	-
WFS150550 – EVO 80 Barrier	H800 x W1200 x D400	9	29
WFS150570 – EVO 80 Barrier Mesh Panel	H560 x W1150 x D38	5	-

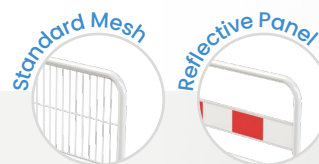

Compatible with both 1m & 1.5m Evo Barriers



*Evo 55 & Evo 80 are both wind tested

Colour Options:

These track safety barriers come in different heights and widths, but each option interlocks to create safe continuous circuits around sharp corners and turns.

Description	Size (mm)	Weight (kg)	Weight Filled (kg)
WFS150600 – RB500 Barrier	H300 x W1250 x D400	10	130
WFS150630 – RB1000 Barrier	H500 x W1000 x D400	10	160
WFS150660 – RB1300 Barrier	H360 x W1100 x D330	8.5	96
WFS150680 – RB1500 Barrier	H500 x W1500 x D400	14.5	266



Colour Options:

These barriers fill with water as the flood rises to form a sturdy and effective barricade, they also connect easily to walls and corners.

Description	Size (mm)	Weight (kg)
FLS180000 – Flood Barrier 500mm	H500 x W1000 x D500	10
FLS180020 – Flood Multi Hub 500mm	H600 x W360 x D590	5
FLS180100 – Flood Barrier Joining Key	-	-

Colour Options:

These 900mm barriers work in the same way as the 500mm options. They fill with flood water and connect with ease.

Description	Size (mm)	Weight (kg)
FLS180010 – Flood Barrier 900mm	H900 x W1000 x D750	26
FLS180030 – Flood Multi Hub 900mm	H900 x W400 x D740	16
FLS180110 – Flood Barrier Joining Key	-	-



We offer many different sizes of concrete barriers which are an effective solution for site safety and security.

Whether you need concrete blocks which need to be stacked or used as a ballast for hoarding as a barricade, we offer an option for you.

All our concrete barriers can be painted in **any colour**.

DID YOU KNOW?



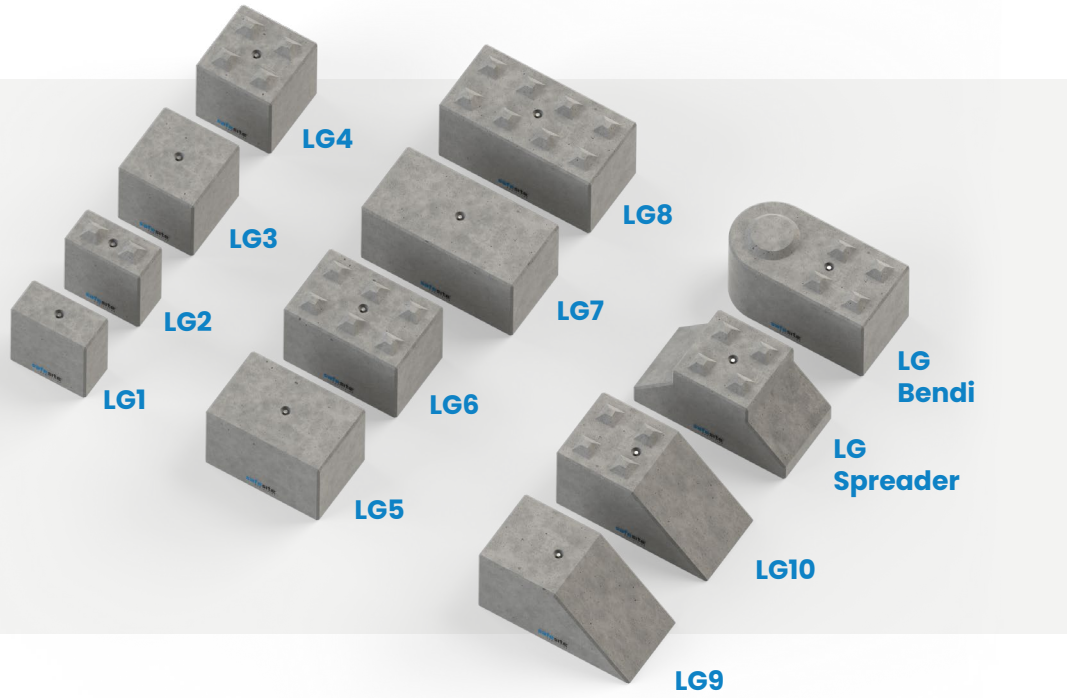

We provide and install barriers, hoarding and mesh fencing for a wide range of sectors including **aviation, rail, road, events, and construction**.

Our products have been tested and approved to meet with a wide range of industry, security and safety standards and can be customised for your needs.



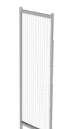

This is a crash-tested concrete barrier which is compatible with mesh fencing. The safety, strength and durability of these barriers means that they're a popular option for highway works.



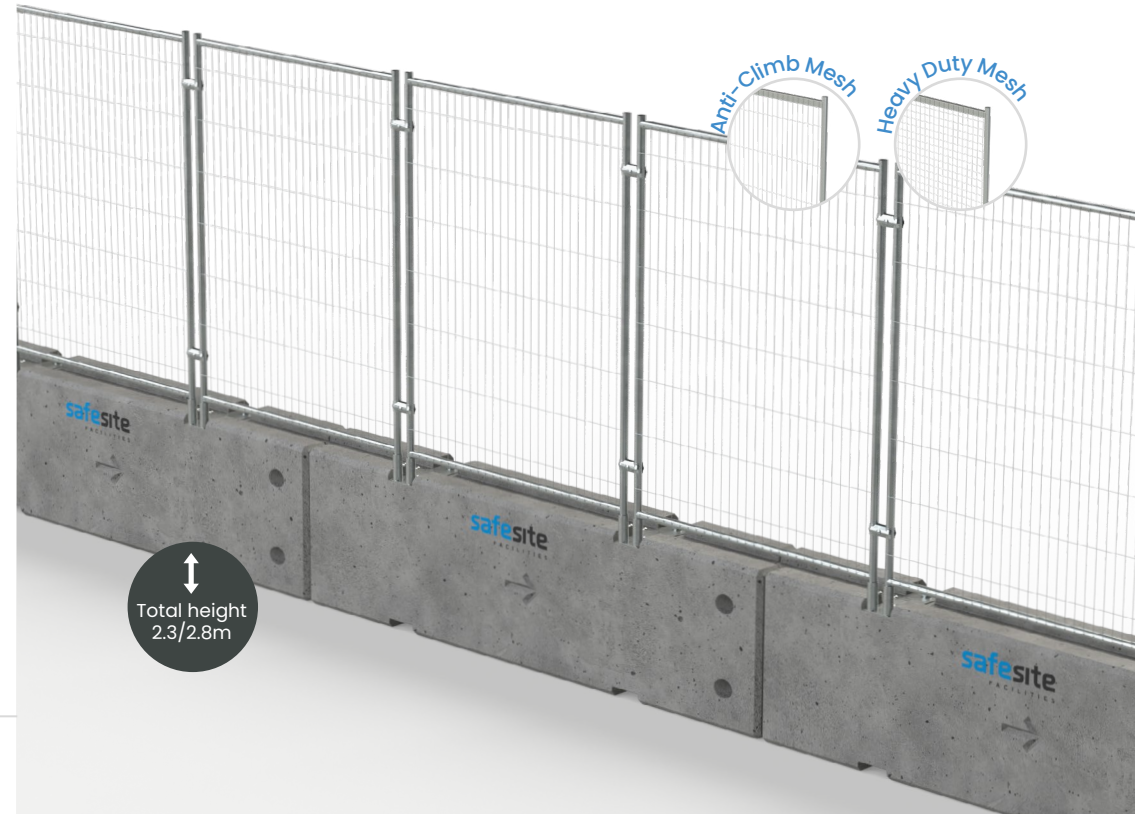

	Description	Size (mm)	Weight (kg)
	CBS120200 TVCB Barrier	H800 x W3000 x D450	2500
	CBS120240 TVCB slopping end section	H800 x W3000 x D450	1700
	CBS120250 TVCB 2m Mesh Panel	H2000 x W1460 x D35	10
	CBS120310 TVCB 1.5m Mesh Panel	H1500 x W1460 x D35	10
	CBS120280 TVCB 2m Mesh End Panel	H2000 x W760 x D35	8
	CBS120350 TVCB 1.5m Mesh End Panel	H1500 x W760 x D35	8

Choose from a range of high strength interlocking concrete blocks that are fire resistant and incredibly durable.

Description	Size (mm)	Weight (kg)
CB2120000 - LG1 Legato Block (Smooth)	H800 x W400 x D800	590
CB2120010 - LG2 Legato Block	H800 x W400 x D800	600
CB2120020 - LG3 Legato Block (Smooth)	H400 x W800 x D800	1185
CB2120030 - LG4 Legato Block	H800 x W800 x D800	1200
CB2120040 - LG5 Legato Block (Smooth)	H800 x W1200 x D800	1775
CB2120050 - LG6 Legato Block	H800 x W1200 x D800	1800
CB2120060 - LG7 Legato Block (Smooth)	H800 x W1600 x D800	2365
CB2120070 - LG8 Legato Block	H800 x W1600 x D800	2400
CB2120080 - LG9 Legato Block (Sloped Smooth)	H800 x W1600 x D800	1800
CB2120090 - LG10 Legato Block (Sloped)	H800 x W1600 x D800	1800
CB2120150 - LG Spreader	H800 x W1600 x D800	1800
CB2120180 - LG Bendi	H800 x W1590 x D800	2240









The smallest of our concrete barriers weighs over 1 tonne. They are perfect to use as access control and assist with traffic control.

	Description	Size (mm)	Weight (kg)
	CBSI20520 1.5m Concrete Barrier	H760 x W1485 x D450	1100
	CBSI20530 2.5m Concrete Barrier	H750 x W2500 x D500	2250
	CBSI20540 3m Concrete Barrier	H760 x W2945 x D440	2250
	CBSI20550 4m Concrete Barrier	H800 x W4000 x D630	4750

Duo Kentledge Block

These barriers are 100% recyclable, resalable, reusable and Chapter 8 compliant. The blocks are also designed to only be moved using specialist machinery.



	Description	Size (mm)	Weight (kg)
	CBSI20600 BL1 (F) Duo Smooth Kentledge Block	H600 x W600 x D450	375
	CBSI20610 BL2 (F) Duo Smooth Kentledge Block	H1200 x W600 x D450	750
	CBSI20620 BL3 (F) Duo Smooth Kentledge Block	H1800 x W600 x D450	1125
	CBSI20650 BL1 Duo Smooth Kentledge Block	H600 x W600 x D450	375
	CBSI20660 BL2 Duo Kentledge Block	H1200 x W600 x D450	750
	CBSI20670 BL3 Duo Kentledge Block	H1800 x W600 x D450	1125

These modular blocks are designed to reroute vehicles and general traffic to protect pedestrian and works during high construction. The barriers interlock to create a seamless, secure connection and can be installed using a standard forklift truck.

	Description	Size (mm)	Weight (kg)
	CBSI20500 2.5m Jersey Interlocking Barrier	H810 x W2500 x D610	1450



Vee Block

B1 Vee blocks have v-shaped grooves and projections to enable them to form a tight connection. They are typically used to create large, solid walls.

	Description	Size (mm)	Weight (kg)
	CBSI20700 B1 Vee 1220 Block	H610 x W1220 x D610	1067
	CBSI20710 B1 Vee 1525 Block	H610 x W1525 x D610	1333

Marquee Blocks

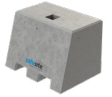
Non-invasive counterweight, marquee blocks feature a forklift slot and screw thread lifting eye to aid installation.

	Description	Size (mm)	Weight (kg)
	CBSI20800 Marquee Block KM1000	H750 x W1030 x D750	1100
	CBSI20810 Marquee Block KM500	H450 x W1030 x D580	480



ORGANISING AN EVENT? WE'RE HERE TO HELP!

At SafeSite Facilities, we can provide a wide variety of event products from **secure fencing** and **concrete barriers** to **toilet hire** and **site clearance**. Affordability, quality and ease of installation make our event products an extremely smart investment to ensure the safety and comfort of your visitors.



Community Events

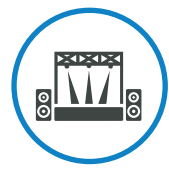

Festivals



Sporting events



Corporate Events



Exhibitions

Pedestrian barriers are an ideal solution for crowd control and creating designated walkways. We stock, deliver, and install options with fixed feet, loose feet, and the ability to expand and contract as required. We strive to offer the maximum number of options available which is why you'll also find gated walkthroughs and illuminated walkways within this section of our catalogue. We custom build and provide stillages for storing pedestrian barriers. Please contact our sales team for more information.



Contact our sales team at info@safesitefacilities.co.uk for more information on your event!

The ease of stacking, transporting and assembling these barriers makes them an industry favourite. They do not require any accessories and easily deal with uneven terrain.



Description	Size (mm)	Weight (kg)
PBS130100 2.3m Fixed Leg Pedestrian Barrier	H1100 x W2262 x D490	14

This loose foot option for the pedestrian barriers means that they can be stacked easily. The detachable feet are sold separately.



Description	Size (mm)	Weight (kg)
PBS130300 2.3m Loose Leg Pedestrian Barrier	H1100 x W2262 x D38.1	12



PBS130350 3.5m Loose Leg Pedestrian Barrier	H1100 x W3450 x D38.1	11
---	-----------------------	----

The concord barrier (also known as the cycle barrier) is made from galvanised tubular steel with anti-climb mesh infill. These barriers work very well with event signage. Stillages also available for storage.



Description	Size (mm)	Weight (kg)
PBS130500 3m Concord Pedestrian Barrier	H1300 x W3000 x D815	35

This barrier features a 705mm angled base for stability.



Description	Size (mm)	Weight (kg)
PBS130550 1.5m Police Pedestrian Barrier	H1065 x W1526 x D705	26

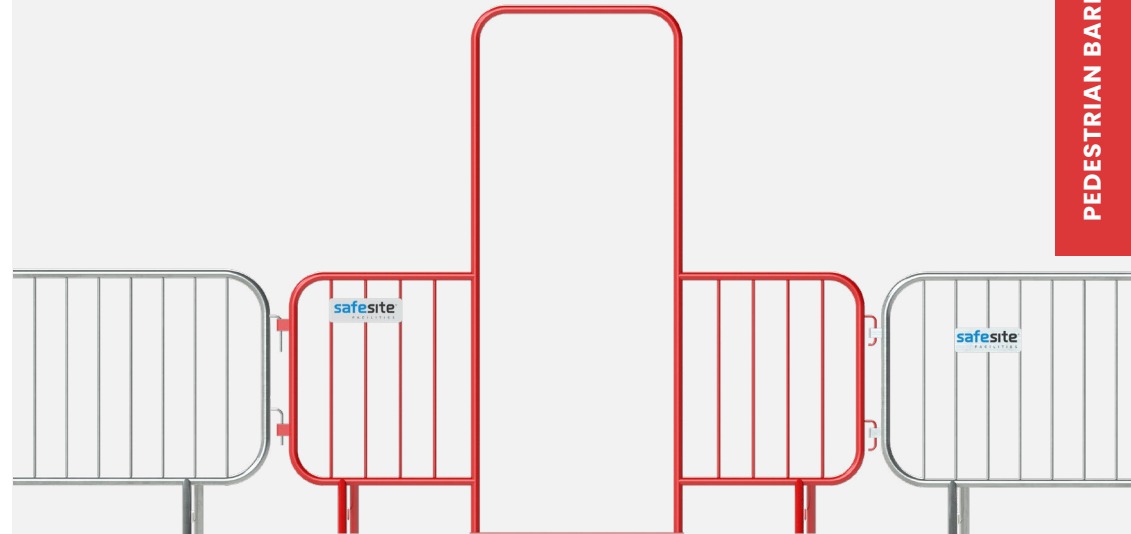

Colour Options:

The walkthrough barrier connects to pedestrian barriers to create a designated access point. The barrier can be supplied with or without a gate. Different gate options are available (see below for more details).

Description	Size (mm)	Weight (kg)
PBS130620 - Without Gate	H2143 x W2266 x D450	12.9
PBS130650 - With Gate & Metal Hinge	H2143 x W2266 x D450	18.7
PBS130700 - With Gate & Plastic Hinge	H2143 x W2266 x D450	14

Different Gate Options Available

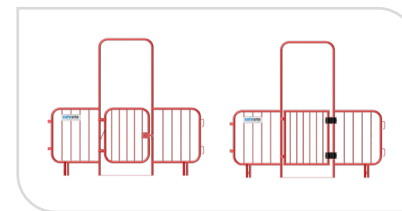

Metal Hinge Gate



Plastic Hinge Gate



Expanding Barriers

Expandable barriers are versatile security and crowd control barriers which are fully retractable and easily stored. Suitable for indoor and outdoor use, the bright and aesthetically pleasant design works well in a wide range of settings and sectors. Its concertina design enables a flexible perimeter.



Colour Options: ● ●

The Centipede II comes in 1.2m and 1.8m heights with options for 2m and 4m expanded widths. Just like a concertina, the barrier contracts and expands as required and can be locked into position and adjoined to another barrier. Utilising an improved full metal construction, the Centipede II is a robust and versatile pedestrian barrier.

Description	Size (mm)	Weight (kg)
RES140405 – 1.2m x 2.1m Centipede Barrier II	H1200 x W2100 x D450	38
RES140435 – 1.8m x 2.1m Centipede Barrier II	H1800 x W2100 x D450	45
RES140480 – 1.8m x 4m Centipede Barrier II	H1800 x W4000 x D450	75

Centipede Barrier

The lighter weight Centipede Barrier is used for crowd and pedestrian management and retracts in a concertina style so it's easy to store and deploy.



Description	Size (mm)	Weight (kg)
RES1400420 – 1.2m Centipede Barrier	H1200 x W2100 x D600	24.5
RES1400430 – 1.8m Centipede Barrier	H1800 x W2100x D600	33.8

Colour Options: ● ●

The Titan Expanders can be used to span an area which varies in size. They connect easily to the titan barrier and stow away neatly for storage.

Description	Size (mm)	Weight (kg)
RES140320 – Titan Expandable Barrier	H1000 x W3100 x D650	10.5



Retractable barriers are ideally suited for indoor use, and create queuing systems with ease.

Description	Base	Size (mm)	Weight (kg)
RES140620 – Belt Barrier	Standard	H1005 x W350 x D350	9
RES140630 – Belt Barrier	Premium	H1005 x W350 x D350	9
RES140640 – Belt Barrier	Stackable	H1005 x W350 x D350	9

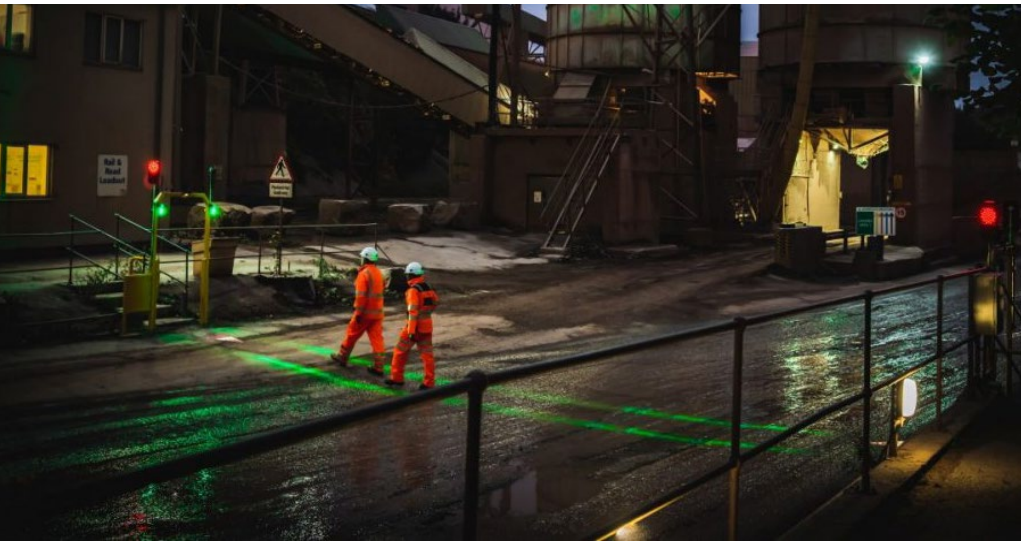

Light up your site in poor weather or lighting conditions with the illuminated walkway.

Description	Size (mm)
PBS132000 - Illuminated Walkway	H1950 x W1000 x D400

The illuminated walkway system alleviates the challenge of on-site communication and offers a safe and efficient solution for protecting your workforce.

The system features a walkthrough barrier with a magilock gate (optional) led traffic light and FHOSS cast protector.

Installation is completed by a specialist team who can offer the best advice on placement and usage.

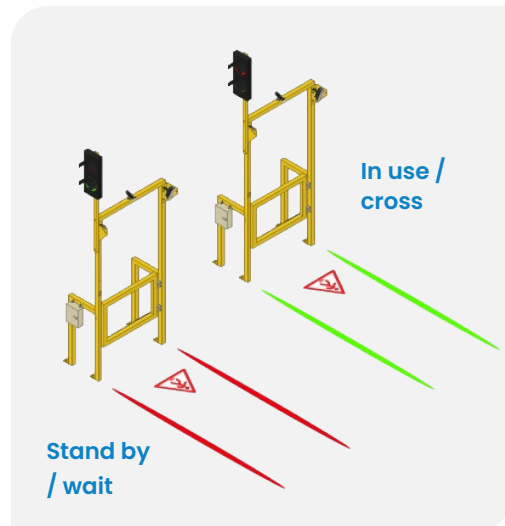

SITE WELFARE ITEMS

We offer a range of site welfare products for all your construction needs, such as the following..



Portable toilets



Hand sanitization stations & dispensers



Large litre gel sanitisers



Cycle & smoking shelters



Lockers and more!

Whatever your site welfare needs, we're happy to help. Contact our friendly sales team for more information about our full range of products and solutions.

WHAT IS CHAPTER 8?

Chapter 8 is a set of regulations and safety measures for traffic management and road works.

Chapter 8 stipulates the requirements for safety measure, signage, and traffic management plans.



High visibility clothing



Safety and visibility



Warning signs



Vehicle markings

Chapter 8 Hi-Vis Compliant Barrier

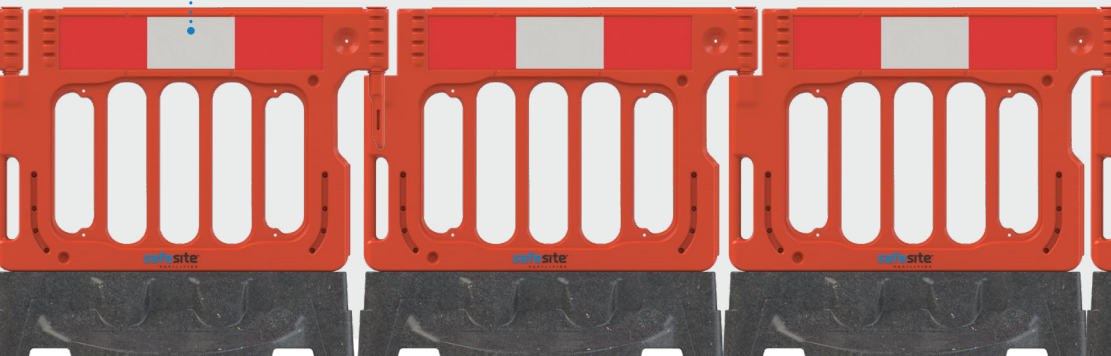

Does your site measure up?

We can advise on the correct barriers, as well as the correct height and visibility measures you need to consider. Contact a member of our sales team for support and guidance.

To learn more about Chapter 8 see the knowledge base section of our website.

We offer a diverse range of products which comply with regulatory requirements and standards for use on highways and construction sites.

Popular products include different types of Chapter 8 gate barriers, crash tested steel barriers and an array of traffic cones.

More information on the different standards that barriers and signage need to adhere to can be found on our website.

Key:  Crash Tested  Wind Tested  Any Colour



Road Barriers

Construction projects which are located close to heavy traffic or fast-moving vehicles such as aircraft, vehicles or trains require barriers which feature crash and wind test credentials for optimum performance and safety.

MANTA
BARRIER

WT CT

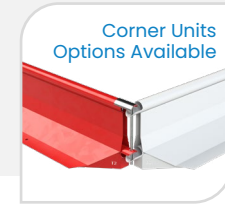

Manufactured in the UK

Colour Options: ● ○

The Manta is a durable, all-weather road safety barrier that is crash and wind tunnel tested, quick and easy to install. The barriers are made from steel for a highly sustainable option for your construction project. They are also compatible with the Mass Barrier.

Description	Size (mm)	Weight (kg)
MTS200000 - Manta Barrier	H420 x W1500 x D500	48
MTS200100 - Manta Corner Sections Type 1	H420 x W1570 x D500	43
MTS200120 - Manta Corner Sections Type 2	H420 x W1505 x D500	43
MTS200180 - Manta End Unit Male	H500 x W660x D490	17
MTS200190 - Manta End Unit Female	H500 x W580 x D490	19
MTS200300 - Manta Connecting Pin	H383 x W140 x D74	1.22
MTS200400 - Manta 3m Mesh Fence Panel	H1580 x W2968 x D38	15
MTS200450 - Manta 1.5m Pedestrian Fence	H580 x W1463 x D38	6



STREETWORKS



Easy To Install

The barriers slot together with ease and secure in place with a pin



Crash tested

Crash tested to T2 W7 levels without reinforcement. Only connection pins are required for this standard



Wind Tested

'Class A' Wind Tunnel Test Certification

No additional reinforcement needed!
Only connection pins required!

Ped Fence

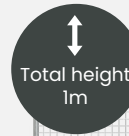

Hi-Vis Ped Fence

Manta Ped Gate

Mesh Fence

Ped Gate

Vehicle Gate

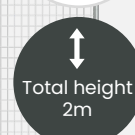

Gates can be added onto the Manta barriers, please see [page 106](#) for more info.

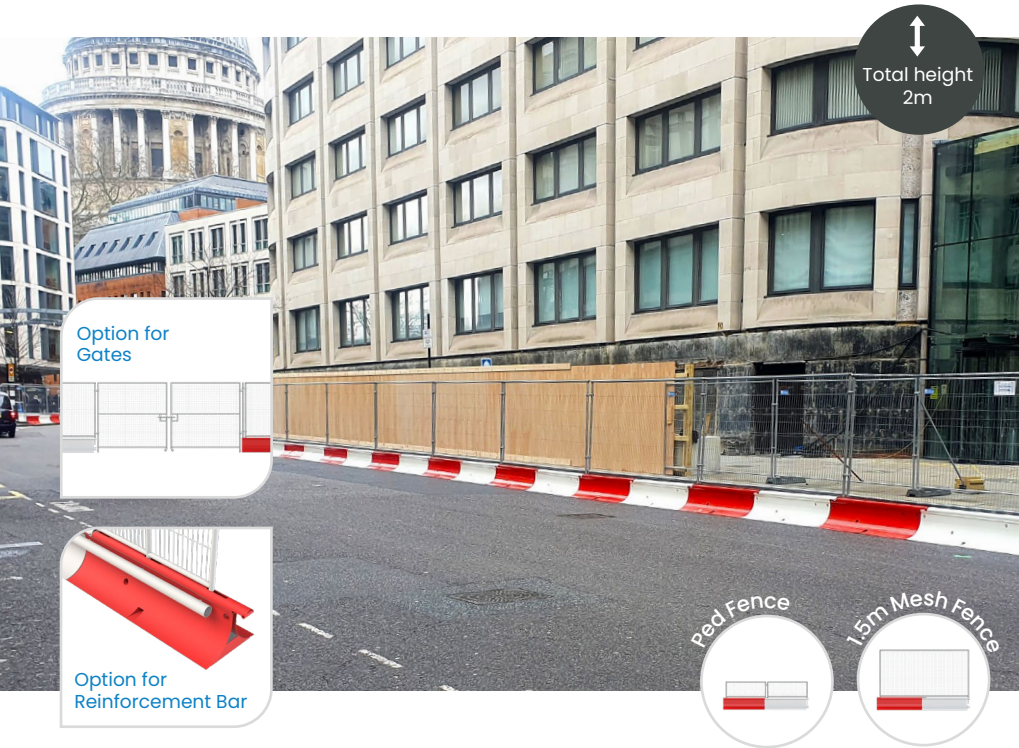

Colour Options: ● ○

The bull barrier is a robust traffic and pedestrian barrier ideal on sites where the workforce will be in close proximity to moving vehicles.

CT*

Description	Size (mm)	Weight (kg)
BUS270000 – Bull Barrier	H405 x W1500 x D516	46
BUS270050 – Bull Barrier End Section Male	H410 x W1140 x D38.1	21.4
BUS270060 – Bull Barrier End Section Female	H410 x W1140 x D38.1	21.4
BUS270080 – Bull Barrier Corner Unit	H410 x W630 x D30	21.4
BUS270150 – Bull Barrier Reinforcement Bar	H80 x W3000 x D160	24
BUS270200 – Bull Barrier Pedestrian Fence Panel	H600 x W1499 x D38.1	9
BUS270220 – Bull Barrier 3m Mesh Fence Panel	H1600 x W2999 x D38.1	21

*A steel reinforcement bar can added to reinforce the Bull barrier to ensure it is crash test compliant.

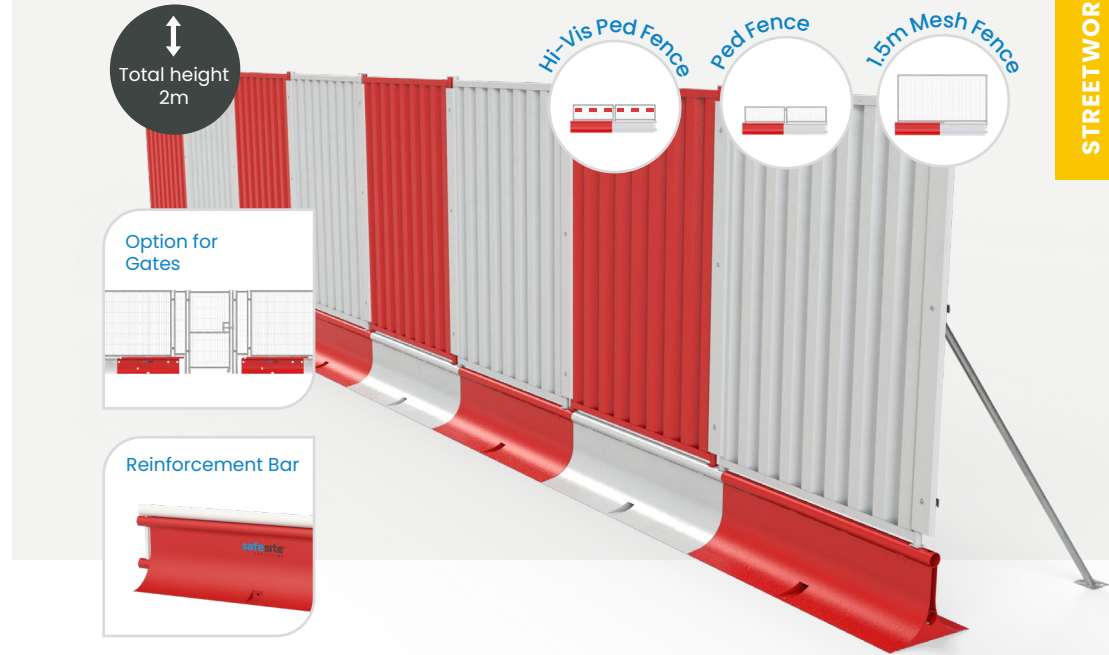

Colour Options: ● ○

The Mass crash barrier is a durable, all-weather road safety barrier that is crash and wind tested. Add a steel reinforcement bar to ensure crash test performance.

CT*

Description	Size (mm)	Weight (kg)
MAS190000 – Mass Barrier	H420 x W1500 x D500	48
MAS190110 – End Unit Male	H500 x W700 x D520	38
MAS190100 – End Unit Female	H500 x W620 x D520	38
MAS190210 – Mass Barrier Corner Unit Male	H420 x W1500 x D500	50
MAS190200 – Mass Barrier Corner Unit Female	H420 x W1500 x D500	50
MAS190380 – Mass Barrier Pedestrian Mesh Panel	H678 x W1500 x D25	11
MAS190400 – Mass Barrier Hi-Vis Pedestrian Mesh Panel	H678 x W1500 x D25	11
MAS190300 – Mass Barrier 1.5m Mesh Fence Panel	H1580 x W2920 x D25	35
MAS190340 – Mass Barrier 1.5m Hoarding Panel	H1980 x W1500 x D30	59



Pre-Installed
Wheels

Colour Options:

The Road Runner self-weighted barrier offers a fast, safe and robust way to create temporary flow paths. The barriers are pre-installed with wheels to assist with moving and positioning.

Description	Size (mm)	Weight (kg)
SBS200750 - Road Runner	H600 x W1140 x D300	22.5

Colour Options:

Self-weighted, these barriers interlock to allow for a continuous safety line, even around corners.

Description	Size (mm)	Weight (kg)
SBS200380 - Mirus Self Weighted Barrier	H650 x W1200 x D380	22

Colour Options:

These logs simply slot and lock into each other for fast and fuss-free deployment.

Description	Size (mm)	Weight (kg)
SBS200800 - Self Weighted Traffic Log	H300 x W1000 x D300	40

Traffic log posts and rails can be added, contact us for more details.

WT



The Boss Barrier offers an innovative solution for managing crowded public spaces like festivals, marathons, and events.

Description	Size (mm)	Weight (kg)
Boss Barrier	H1100 x W2000 x D50	9.9



Additional Ballast
Available



See our ballast and stabilisation section on [page 111](#) for our range of products.

WT

Colour Options:

The gate barrier is wind tested and a solid choice for construction sites and road works.

Description	Size (mm)	Weight (kg)
SBS200050 - 2m Gate Barrier With Anti-Trip Feet	H1000 x W2000 x D50	8.9
SBS200100 - 2m Gate Barrier With Standard Feet	H1000 x W2000 x D50	8.9

Colour Options: 

Made from HDPE these moulded barriers interlink with a simple hook and loop method.

Description	Size (mm)	Weight (kg)
SBS201400 – Avalon Barrier	H1000 x W2000 x D50	5
MTS201410 – Standard Gate Barrier Foot	H830 x D76	2
MTS201415 – Anti-Trip Gate Barrier Foot	H830 x D76	2

Colour Options: 

The Firmus Barrier is made from HDPE and the universal pin system means that they can connect with other barriers.

Description	Size (mm)	Weight (kg)
SBS200300 – Firmus Barrier	H1075 x W2035 x D42	12
SBS200310 – Standard Gate Barrier Foot	H830 x D76	2
SBS200320 – Anti-Trip Gate Barrier Foot	H830 x D76	2

Colour Options: 

The Titan is available in 1.5m and 2m lengths and can be clipped to the expanding versions of the same barrier. They are 100% recyclable and easy to stack for compact storage.

Description	Size (mm)	Weight (kg)
SBS200400 – 1.5m Titan Barrier	H1005 x W1530 x D50	13.5
SBS200410 – 2m Titan Barrier	H1005 x W1930 x D50	14.6

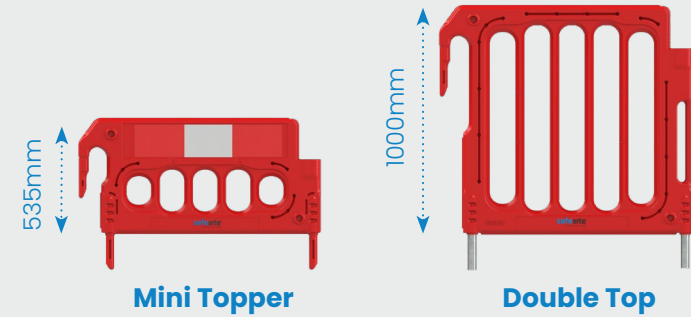

FAST FIT TOPPERS

You can quickly add height to the following water filled barriers with the mini topper and double top panels. The WonderWall barriers feature a removable recycled plastic base which acts as excellent ballast and works similarly to the StrongWall. See page 50 & 51 for more info.



Hog 600 Barrier

Buddha Barrier

WonderWall Barrier

Total heights

Streetwork Barriers	Mini Topper	Double Top
Hog 600 Barrier	1.1m	1.56m
Buddha Barrier	1.35m	1.81m
WonderWall Barrier	1.54m	2m

Colour Options: ● ○

The StrongWall is a heavy duty plastic barrier onto which you can add a mesh or plastic fence panel. These are quick and easy to install and feature a rubber base which is made from recycled plastic.

Description	Size (mm)	Weight (kg)	Weight Filled (kg)
SBS200900 – StrongWall Barrier	H1000 x W1000 x D520	22	37
SBS200930 – StrongWall Barrier Plastic Fence Panel	H1000 x W1000 x D60	3.5	-
SBS201090 – StrongWall Barrier Mesh Fence Panel	H1060 x W965 x D38	5	-

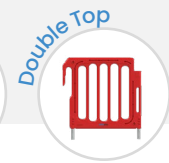

Colour Options: ●

The WonderWall is a durable, robust barrier with a rubber base. Whilst we stock the barrier in yellow and orange, it can be manufactured in any RAL colour.

Description	Size (mm)	Weight (kg)
SBS200050 – WonderWall Barrier	H1000 x W1140 x D500	25
SBS201090 – WonderWall Mesh Fence Panel	H1060 x W965 x D38	5
SBS200990 – Mini Topper Panel	H535 x W1115 x D50	3
SBS201130 – Double Top Panel	H1000 x W1115 x D60	2.8



The V-Fence Barrier provides an lightweight alternative solution to traditional metal heras fencing that is quick to install and is also a hi-vis chapter 8 panel.

Description	Size (mm)	Weight (kg)
SBS200250 - V-Fence Barrier	H2005 x W1000 x D75	8.2



These are hinged barriers which are used to surround utility holes and span areas to restrict access. Compact, lightweight, and 100% recyclable, these make excellent street work barriers.

Description	Size (mm)	Weight (kg)
SBS200200 - SafeGate Barrier 3 Part	H1000 x W2250 x D60	6
SBS200220 - SafeGate Barrier 4 Part	H1000 x W3000 x D80	10
SBS200230 - SafeBase Barrier Stabilisation Foot	H80 x W340 x D340	2.6



Postman Barrier

This is a modular system which includes 1.25m and 2m wide reflective planks. The system can be used to create lines or box formations and is 100% recyclable.

Description	Size (mm)	Weight (kg)
SBS200550 - Postman Barrier 2m Plank	H176 x W2000 x D30	2.2
SBS200560 - Postman Barrier 1.25m Plank	H176 x W1250 x D30	1.75
SBS200580 - Postman Barrier Base	H128 x W445x D445	4
SBS200590 - Postman Barrier Posts	H1150 x W100 x D100	1



Thor Barrier

These are highly stable, durable barriers which can be used in combination with various bases. The barriers connect together with ease and can be used with signage and lamps. They are also customisable and recyclable.

Description	Size (mm)	Weight (kg)
SBS201300 - Thor Barrier	H1060 x W2060 x D50	9.5

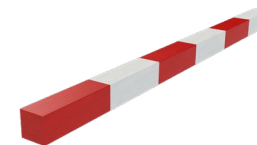

Baulk Timber

Also known as wood sleepers, baulk timber is used next to roadways to stop traffic, protect pedestrians and construction works. The timbers are wax painted red and white to maximise visibility.

Description	Size (mm)	Weight (kg)
SBS200845 - Small Baulk Timber	H200 x W6000 x D200	72
SBS200850 - Std Baulk Timber	H300 x W6000 x D300	216



ARMCO

Armco barriers are used to provide safety in a variety of places such as highways, car parks and construction sites. They are made from robust galvanised steel, strong enough to withstand the impact of a car and prevent collisions.

We provide a range of accessories and options for ARMCO barriers.

Get in contact with our sales team for all of your streetwork needs - email info@safesitefacilities.co.uk



NEED ROADWORKS SIGNAGE FOR YOUR SITE?

Traffic signs play a vital role directing, controlling and informing road users behaviour. Signage needs to meet with requirements set out by British Standards, Streetworks and the Chapter 8 manual.

We provide different sizes and options for streetworks signage. Get in contact with our sales team for all of your streetwork needs - email info@safesitefacilities.co.uk

Speed Ramps & Road Plates

Speed ramps are an effective way to calm traffic and make road flow slower and safer. Road plates are a quick and easy way to cover temporary excavations and feature an anti-slip aggregate on the surface.



Traffic calming speed ramps have good grip in wet conditions and can be easily bolted to the floor.

Description	Size (mm)	Weight (kg)
STS210050 - Speed Ramp 30mm x 500mm	H30 x W500 x D480	8
STS210060 - Speed Ramp 30mm End Piece	H30 x W210x D480	3
STS210070 - Speed Ramp 50mm x 500mm	H50 x W500 x D480	8
STS210080 - Speed Ramp 50mm End Piece	H50 x W210x D480	3
STS210090 - Speed Ramp 75mm x 500mm	H75 x W500 x D480	11.5
STS210100 - Speed Ramp 75mm End Piece	H75 x W210 x D480	5.5



Road Form

Made from steel, road forms are used as a form of shuttering for concrete slabs or floors. They are 3m in length and connect using joiners to create the size and shape required.

Description	Size (mm)	Weight (kg)
STS210300 - Road Form - 4" 3m Flexi	H100 x W3000	14.5
STS210310 - Road Form - 6" 3m Flexi	H150 x W3000	19.5
STS210320 - Road Form - 4" 3m Square Edge	H110 x W3000	21
STS210330 - Road Form - 6" 3m Square Edge	H150 x W3000	25.8
STS210340 - Road Form - 8" 3m Square Edge	H200 x W3000	30.5
STS210380 - Road Form Stake 20mm x 450mm	H450 x W20	1.73
STS210390 - Road Form Stake 20mm x 600mm	H600 x W20	2.31

Ramps

We stock and deliver a range of anti-slip and heavy duty ramps for facilitating pedestrian and vehicular access on roads or kerbs.



Cable/Hose Protection Ramp

Install a cable/hose protection ramp for temporary or semi-permanent applications such as construction sites, emergency works and road works. The ramps allow for cables to run over roads without complication.

Description	Size (mm)	Weight (kg)
STS210200 - Large 3 Channel Cable/Hose Protection Ramp	H75 x W960 x D600	5.5
STS2100210 - Large 2 Channel Cable/Hose Protection Ramp	H50 x W1000 x D50	4
STS210250 - HD Hose and Cable Ramp	H100x W900 x D615	26



Adjustable, anti-slip safe kerbs ensure easy and fair access for wheelchairs. The ramps also feature raised sides to provide extra safety.

Description	Size (mm)	Weight (kg)
STS210950 - SafeKerb Wheelchair Ramp	H112 x W1265 x D747	6



Safe Kerb SupaGrip Ramp

SupaGrip Ramps are adjustable, and feature an anti-slip surface to ensure easy and fair access for wheelchairs. The ramps also have raised sides to provide extra safety.

Description	Size (mm)	Weight (kg)
STS210960 - SupaGrip SafeKerb Wheelchair Ramp	H110 x W1280 x D760	10

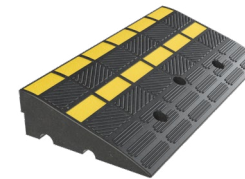



TrafficLine Kerb

These ramps are a fast and easy way to enable wheelchairs, trolleys, and vehicles to mount a kerb. They feature reflective yellow strips and channels to allow water to filter through and can withstand vehicle weights of up to 40 tonnes.

Description	Size (mm)	Weight (kg)
STS211050 - HD TrafficLine Kerb Ramp 100mm	H100 x W600 x D300	11
STS211060 - HD TrafficLine Kerb Ramp 150mm	H150 x W600 x D360	20

Bollards, posts and cones

We stock and supply a range of goal posts, bollards and cones for various types of sites and scenarios. Our range includes self-supported as well as more permanent, 'in ground' options.

Colour Options:  

The GS6 Height restriction barriers warn vehicles to the danger of overhead cables, bridges, and powerlines. The posts sit in steel bases or ballast blocks to secure in place.

Description	Size (mm)	Weight (kg)
STS211400 – Goal Post Telescopic Posts	H1800 (7300MAX) x W50 x D50	3.5
STS211410 – Goal Post Steel Bases	H7300 x W7600 x D500	13.5
STS211420 – Goal Post Bunting	W25000	0.3
STS211430 – Goal Post Solid Bar	H50 x W1800 (7300MAX) x D50	3.9
STS211440 – Goal Post Water Filled Bases	H520 x W500 x D500	8.5



Bell Bollard

Made from cast iron, the bell bollard is hard-wearing and can last over 25 years. They are traditionally used to protect public spaces and pedestrians from vehicles mounting pavements, street corners and curb sides.

Description	Size (mm)	Weight (kg)
STS211500 – Bell Bollard	H475 x W600 x D600	165
STS211510 – Bell Bollard (Half)	H475 x W300 x D600	125
STS211520 – Bell Bollard (Three Quarter)	H620 x W315 x D615	120
STS211530 – Bell Bollard Kerbline	H475 x W600 x D600	80



3Sixty Bollard

The 3Sixty self-righting bollard conforms to BS 8442 and crash tested to BS EN 12767. Made from plastic with a rubber base, it is covered with a rigid reflective material and is proven to be weather resistant.

Description	Size (mm)	Weight (kg)
STS211550 – 3Sixty Bollard – Keep Left	H960 x W370 x D85	5
STS211560 – 3Sixty Bollard – Keep Right	H960 x W370 x D85	5
STS211570 – Anchor Cradle for 3Sixty Bollard	H60 x W210 x D210	1.2

Protectors are incredibly strong and suitable for indoor and outdoor use. Air pressure release cushions to minimise impact and prevent damage.

Description	Size (mm)	Weight (kg)
STS211650 – Column/Pillar Protector S200	H1100 x D610	27
STS211660 – Column/Pillar Protector S300	H1000 x D610	27



Flexible Traffic Posts

Commonly used in car parks, shipping yards and driver training, these bollards feature a heavy-duty cord so they flex and spring back into position. They are made from UV stabilised HDPE and designed for extended external use.

Description	Size (mm)	Weight (kg)
STS211900 – Flexible Highway Post	H1000 x W100 x D100	2.5

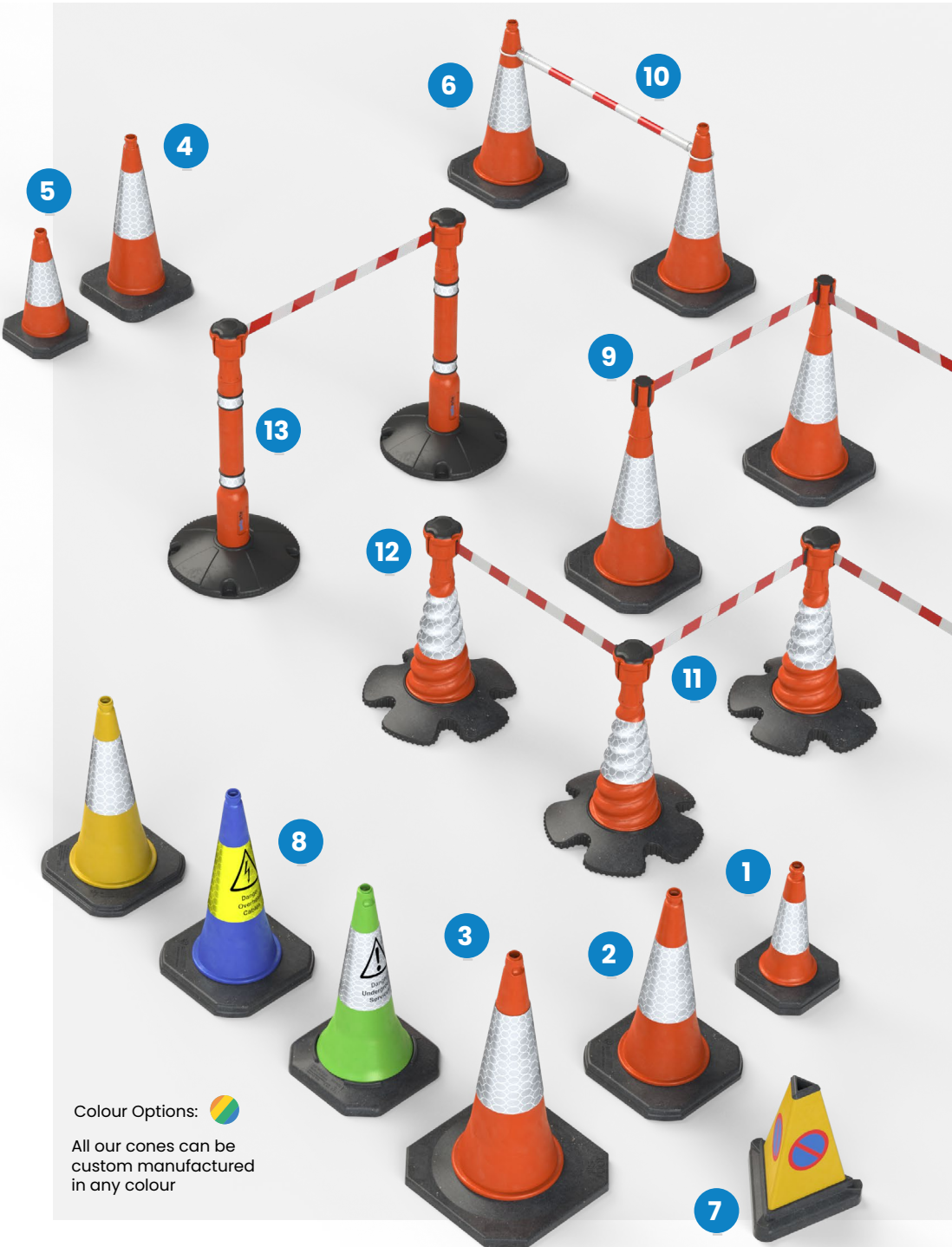

Colour Options: 
 All our cones can be custom manufactured in any colour

We stock and supply a range of cones and accessories. The popularity of cones in construction is undoubtedly due to how fast and easy they are to deploy. Add accessories such as high visibility tape, posts, and poles to increase the versatility and reach of these one and two-piece units.

	Description	Size (mm)	Weight (kg)
1	STS211950 - 500mm 2 Piece Cone	H500 x W270 x D270	2.75
2	STS212060 - 750mm 2 Piece Cone	H750 x W290 x D290	4.75
3	STS212070 - 1000mm 2 Piece Cone	H1000 x W550 x D550	7
4	STS212100 - 750mm 1 Piece Cone	H750 x W380 x D270	3
5	STS212110 - 450mm 1 Piece Cone	H450 x W290 x D270	3
6	STS212120 - Big Foot Road Cone	-	-
7	STS212170 - 'No Waiting' Cone	H540 x W270 x D270	3
8	STS212190 - Cone Sleeves	-	-
9	STS212210 - Cone Topper Set Tape 3.65m	H232 x W3650 x D50	0.5
10	STS212250 - Telescopic Demarcation Pole	H450 x W1100-2200 x D270	0.6

Skipper manufactures a number of products which can be quickly added to cones to increase their versatility and value on site.

	Description	Size (mm)	Weight (kg)
11	STS212290 - Skipper Cone	H750 x W555 x D555	5.4
12	STS212300 - 9m Skipper Unit	H240 x W145 x D145	0.795
13	STS212340 - Skipper Post & Base System	H1000 x W500 x D500	2.3

Additional Items



Skipper Wall Support Bracket



Skipper Receiver Clip



Skipper Rechargeable Safety Light



MonoLight LED



The X-ECO Mobile Lighting tower is rugged, long lasting and safe. It guarantees an illuminated area of 3800 sqm, which automatically sparks into life once the sensors detect dim lighting. The lighting unit has technology which allows for maximum fuel efficiency and reliability.

Description	Size Retracted (mm)	Size Extended (mm)	Weight (kg)
PHS700500 - X-ECO Mobile Lighting Tower	H2420 x W2320 x D1380	H8500 x W2320 x D1550	920



FAST & EFFICIENT DELIVERY

WE HAVE YOU COVERED!

You need to know that you can rely on your product being delivered to the right place at the right time.

Our fleet of vehicles can deliver our products Nationwide, we also have the capability to deliver anywhere across Europe.

We have also been awarded FORS gold which confirms that we demonstrate dedication to driver and vehicle safety, and effective operations and fuel efficiency.

**NATIONWIDE
DELIVERY!**

INTERESTED IN OUR USED STOCK?



Contact our
Sales team on
0800 012 5352

We have used mesh, hoarding, concrete, and water filled barriers available to buy. These products are ex-hire or 'buy backs' that we ensure are fit for use. As second-hand stock, these may have scuffs and scratches but will still prove effective for the task at hand.

Concrete barriers last for decades and are perfect for use as low cost, high security barricades. Used stock is particularly good for remote or discreet locations where aesthetics are less significant. We also provide pictures of the actual items so you can be sure of receiving a quality product from us.

REASONS TO BUY USED STOCK:

- ✓ Budget-friendly
- ✓ Great for small projects
- ✓ It's good for the environment
- ✓ Quality assured

PARKING CONTROL

Maximise the security of your site or parking facility with the addition of security bollards, wheel stops, manual and automatic arm barriers.



These height restricting barriers are used for parking control and are manufactured from steel and fitted with a tube knocking bar and chain.

Description	Size (mm)
PCS630020 – 4m High x 4m Wide	H1200 x W2100 x D450
PCS630040 – 3.8m High x 6m Wide	H1800 x W2100 x D450

Height restrictors can be custom manufactured to order. Please contact our sales team with your specific requirements.



Our automatic barriers are a useful addition to your perimeter security solution. Commonly used in parking facilities and check points, automatic barriers are a useful tool for restricting vehicle site access.

Description	Size (mm)
PCS630100 – Automatic Raise 7m Arm Barrier	H450 x W7000

These parking barriers can be customised to requirements such as lengths of 3-7 metres.

Description	Size (mm)
PCS630200 – Standard Manual Arm Barrier – 3m	H1135 x W3000 x D450
PCS630210 – Standard Manual Arm Barrier – 4m	H1135 x W4000 x D450
PCS630220 – Standard Manual Arm Barrier – 5m	H1135 x W5000 x D450
PCS630230 – Standard Manual Arm Barrier – 6m	H1135 x W6000x D450
PCS630240 – Standard Manual Arm Barrier – 7m	H1135 x W7000 x D450
PCS630250 – Standard Manual Arm Barrier – 8m	H1135 x W8000 x D450

Options for Heavy Duty version



Security Bollards

Colour Options:

This heavy-duty parking post is painted black and yellow and features a durable base. The bollards are simple to install and ideal for use for vehicle restriction in warehouses and car parks.

Description	Size (mm)
PCS630500 – 1m Security Bollard	H1020 x W200 x D200



Wheel Stop Kit

Typically used to prevent unauthorised parking, heavy duty kerb stops can also be used to protect walls, racking, and machines such as car charge points. They are made from high density rubber and feature yellow chevrons to maximise durability and visibility.

Description	Size (mm)
STS211150 - 900mm Wheel Stop Kit with fixings	H11 x W1200 x D2400
STS211160 - 1650mm Wheel Stop Kit with fixings	H18 x W1200 x D2400
STS211160 - 1800mm Wheel Stop Kit with fixings	H18 x W1200 x D2400
STS211160 - 2000mm Wheel Stop Kit with fixings	H18 x W1200 x D2400

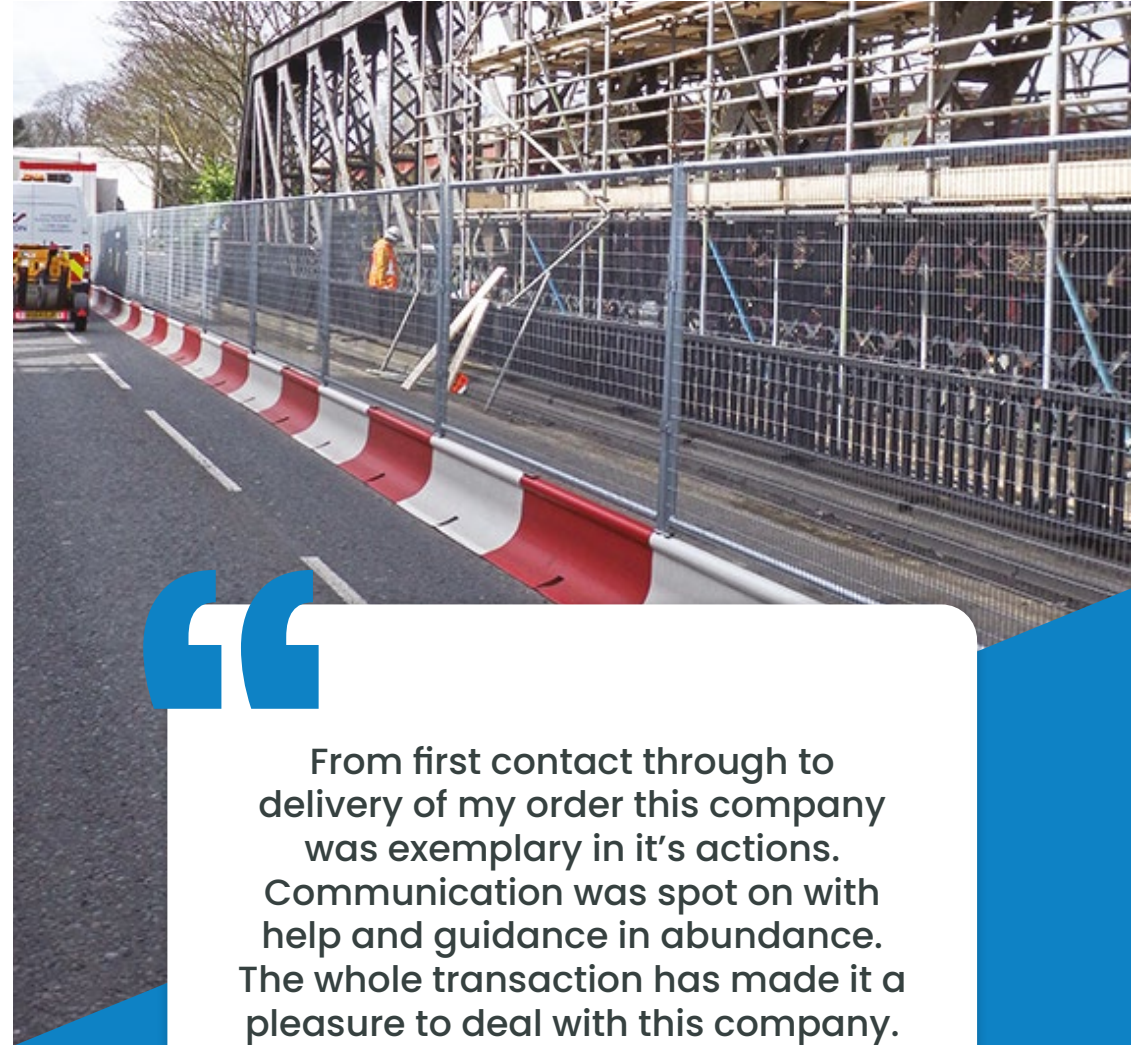

From first contact through to delivery of my order this company was exemplary in it's actions. Communication was spot on with help and guidance in abundance. The whole transaction has made it a pleasure to deal with this company.



P. T.





SAFESITE

LIVECHAT

We have LiveChat where a SafeSite staff member is happy to help!

Our sales team are available on the phone and LiveChat, **Monday to Friday 8am-5:30pm.**

We can advise on the best product, and provide the most competitive quote possible.

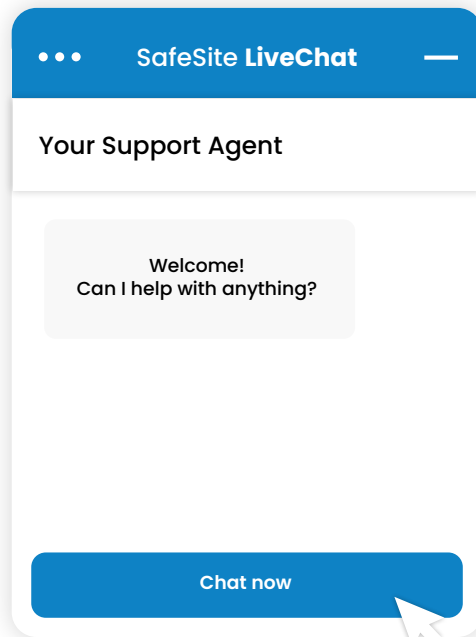

Our ground protection products offer a solution for all-weather construction works and sites. Choose from a range of products which includes GRP safety grating, walkways, ground plates and more.

If you need something that's not featured in this section, our sales team will be more than happy to source and provide the solution you need.





Steel road plates seal off dangerous holes and excavations to keep your site, personnel and vehicles safe. We offer both plain steel and anti skid options of various sizes and weights.

Description	Size (mm)	Weight (kg)
STS210500 - Plain Steel 11mm Thick 1.2m x 2.4m	H11 x W1200 x D2400	250
STS210510 - Plain Steel 18mm Thick 1.2m x 2.4m	H18 x W1200 x D2400	420
STS210520 - Plain Steel 11mm Thick 1.2m x 1.2m	H11 x W1200 x D1200	125
STS210530 - Plain Steel 18mm Thick 1.2m x 1.2m	H18 x W1200 x D1200	210
STS210560 - Anti Skid Coating 11mm Thick 1.2m x 2.4m	H11 x W1200 x D2400	270
STS210570 - Anti Skid Coating 18mm Thick 1.2m x 2.4m	H18 x W1200 x D2400	440
STS210580 - Anti Skid Coating 11mm Thick 1.2m x 1.2m	H11 x W1200 x D1200	135
STS210590 - Anti Skid Coating 18mm Thick 1.2m x 1.2m	H18 x W1200 x D1200	220

Ask our sales team for other sizing options



Heavy duty road plates offer a light and long-lasting alternative to steel road plates. No plant or lifting machines are required, and the plates can be installed with a 2-person lift.

Description	Size (mm)	Weight (kg)
STS210650 - GRP Road Plate 1.4m x 1.2m	H75 x W1400 x D1200	47
STS210670 - GRP Road Plate 1.5m x 0.5m	H75 x W1500 x D500	44
STS210690 - GRP Road Plate 1.5m x 0.5m End Piece	H75 x W2300 x D500	23
STS210710 - GRP Road Plate 2.3m x 0.5m	H75 x W2300 x D500	-
STS210730 - GRP Road Plate 2.3m x 0.5m End Piece	H75 x W2300 x D500	-
STS210780 - GRP Road Plate Fixing Bolts	H75 x W2300 x D500	-



Supa-Trac

These ramps are designed to be used alongside event mat and eliminate any trip hazards for easy vehicle access.

Description	Size (mm)	Weight (kg)
Supa-Trac Ground Covering	H275 x W966 x D27	2
STS211100 – Supa-Trac Ramp	H225 x W90 x D27	0.2



TerraGuard™

TerraGuard creates a firm surface for pathways, roads, temporary buildings as well as helipads and car parks. The heavy duty ground protection supports vehicles up to 2 tonnes and greater static weights.

Description	Size (mm)	Weight (kg)
TerraGuard™	H287.5 x W575 x D30	1.33



The cover is designed to comfortably bridge upto a 900mm hole or trench to create a permanent or semi-permanent solution quickly and easily.

Description	Size (mm)	Weight (kg)
STS211250 – Safe Cover 1.2m x 0.8m	H30 x W1200 x D800	13
STS211260 – Safe Cover 1.6m x 1.2m	H26 x W1600 x D1200	33

The covers can be quickly installed, and the black rubber edges grip the asphalt.

Description	Size (mm)	Weight (kg)
STS211300 – 1.125m x 1.125m LowPro Cover	H17 x W1125 x D1125	24
STS211320 – 1.2m x 0.8m LowPro Cover	H28 x W1200 x D800	17
STS211330 – 1.5m x 1m LowPro Cover	H37 x W1500 x D1000	38



SafeMat creates a 'non slip' surface that performs in the most challenging weather conditions.

Description	Size (mm)	Weight (kg)
GPS230300 – 2.4m Safe Mat	H15 x W2400 x D1200	44
GPS230310 – 3m Safe Mat	H15 x W3000 x D1200	44



This plastic gravel grid interlocks to create a porous paving system to reinforce the ground. The grids expand and contract with the weather and are made from 100% recycled plastic and are recyclable. Endura Grids are ideal for creating paths, car parks and can withstand the weight of 44t vehicles.



Description	Size (mm)	Weight (kg)
GPS230050 – Endura Grid Wall 4mm	H65 x W500 x D500	2



Suitable for work sites and events, these heavy duty Endura Mats provide road access for vehicles and pedestrians and can be installed quickly and easily.

Description	Size (mm)	Weight (kg)
GPS230070 – Endura Mat Ground Guard	H12 x W2440 x D1220	32
GPS230090 – Endura Mat Joint Clip	H12 x W2440 x D1220	-



Colour Options:   

This mat is made from recycled plastics and designed to be simple and easy to use. Simply place the mat on the ground.

Description	Size (mm)	Weight (kg)
GPS230200 – Clear Path Mat 4mm	H22 x W1200 x D600	20



Ground guards can be placed side by side to create large areas of ground protection including flooring and walkways.

Description	Size (mm)	Weight (kg)
GPS230900 – Ground Guard MultiTrack Mat	H13 x W2400x D1200	39



Safe Walk Matting

Safe Walk Matting is a great solution for creating walkways and clearly visible, defined crossing points for pedestrian/workforce safety and comfort.

Description	Size (mm)	Weight (kg)
GPS230250 – Safe Walk Matting	H22 x W1200 x D800	20





Hardwood Bog Mat

Also known as 'crane mats' or 'timber mats', hardwood bog mats are FSC certified and create a steady surface on muddy or slippery ground for machinery, people, and materials.

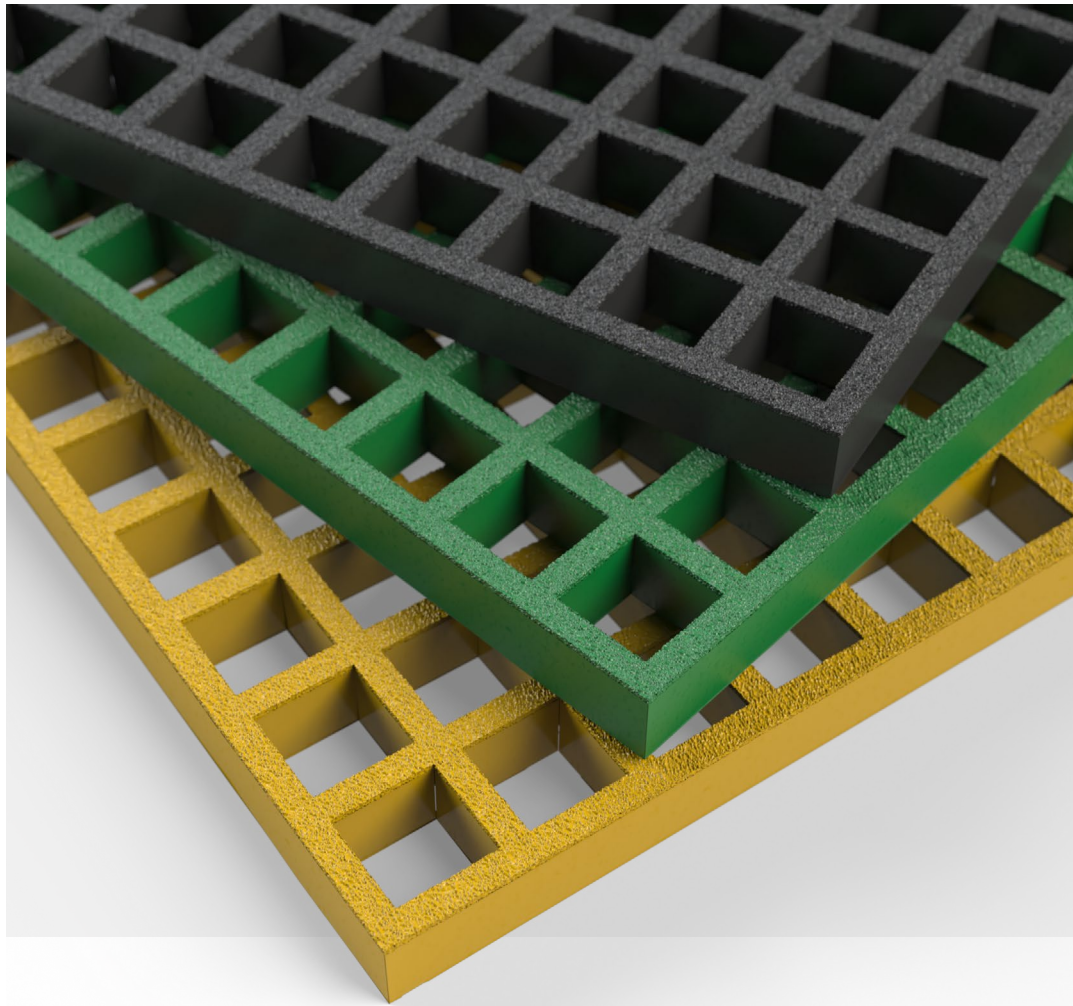
Description	Size (mm)	Weight (kg)
GPS230850 – 140mm Hardwood Bog Mat	H140 x W5000 x D100	700
GPS230860 – 150mm Hardwood Bog Mat	H150 x W5000 x D100	750



Colour Options:   

GRP safety grating is a type of safety grating made from glass reinforced plastic (GRP), also known as fibreglass reinforced plastic (FRP).

Description	Size (mm)	Weight (kg)
STS210850 - GRP Safety Grating	H26 x W3043x D993	31

We also offer a number of other types of ground mats. Please contact our sales team with your specific requirements.



Fantastic & friendly customer service.
 Delivery was made a day ahead.
 We will definitely recommend your
 company & come to you if we need
 anything in the future.



C. W.

safesite[®]
 FACILITIES



safeSite INSTALLATIONS

Our installation process couldn't be easier!



We will deliver to your site anywhere in the UK within 24 hours of contact



We can install all our products from temporary fencing to water filled barriers on your behalf in a safe, efficient and professional manner



Browse our range of mesh and solid panel systems. Learn more about the sustainable and reusable options we offer, in addition to the appropriate ballast and stabilisation advised.

Free site inspections are offered as standard, and our experienced teams will deliver and install anywhere in the UK. Our hoarding panels are powder coated and can be custom painted according to your requirements.



DID YOU KNOW?

TEMPORARY FENCING & HOARDING

Temporary Fencing Options

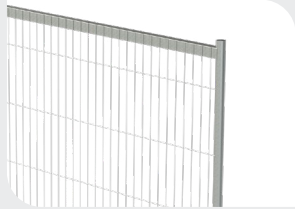

Anti-climb fence panels

Our most popular type of fence panel. Cost effective and protects your site from potential intruders with both vehicle and pedestrian gates available.

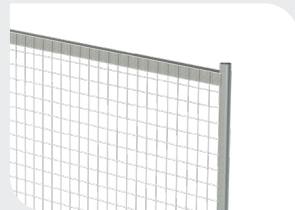

Heavy duty panels with mesh

Stronger and more durable than our other types of panels. Used at events and on construction sites for demarcation and wind tested up to 57mph.

Temporary Hoarding Options



Temporary Steel Hoarding

Free standing so no digging or excavation required which makes this a short-term and cost-effective option. Ideal for events and construction sites.

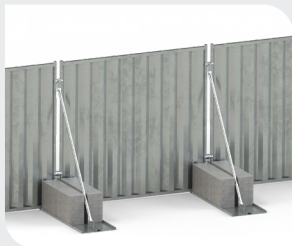

On-ground steel hoarding

On ground hoarding is installed directly on the ground and is ideal for roads and pavements where excavation is not possible. Takes only minutes to install!



In-ground steel hoarding

Often regarded as a robust site perimeter best suited to long term construction projects. A portion of the hoarding is buried in the ground.

Also known as heras or mesh fencing, temporary fencing is self supporting panels. We offer anti-climb and heavy duty options of mesh fencing.

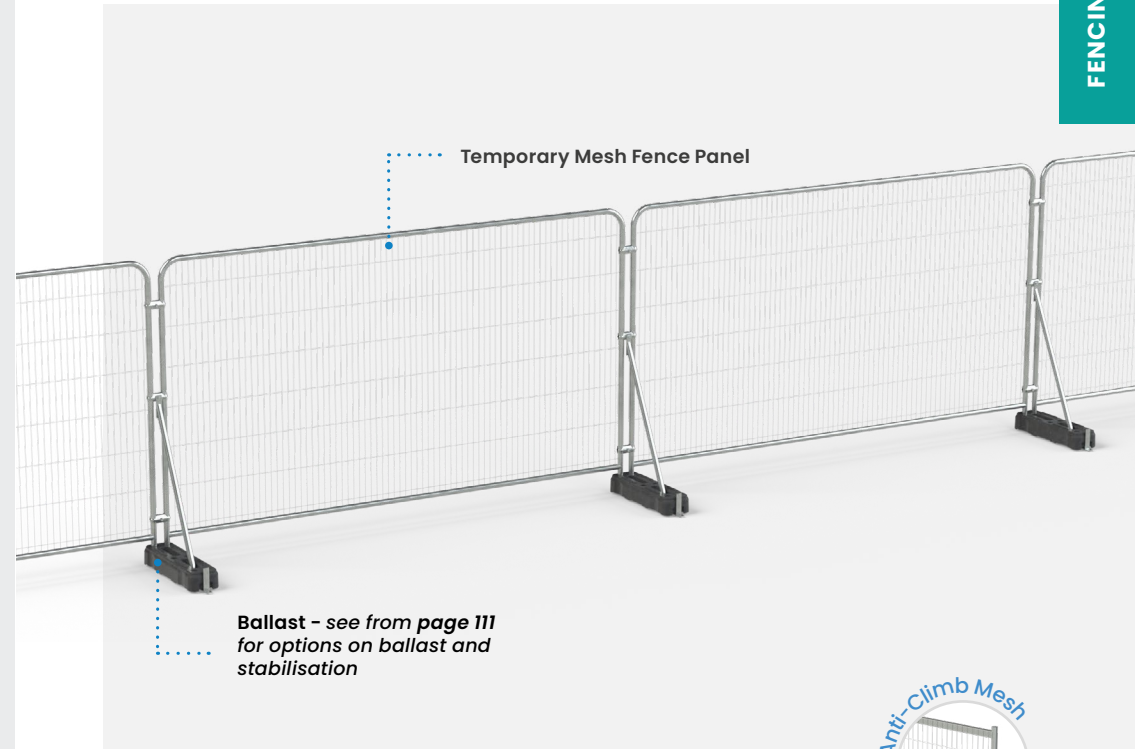

Colour Options:



Description	Size (mm)	Weight (kg)
TFS100110 - 2m Std Temporary Mesh Fencing (Square)*	H2025 x W3450 x D40	10.5
TFS100130 - 2m Temporary Mesh Fencing (Square)	H2025 x W2140 x D40	12.2
TFS100150 - 2m HD Temporary Mesh Fencing (Square)	H2025 x W2140 x D40	14.9
TFS100050 - 2m HD Temporary Mesh Fencing (Rounded)	H2000 x W3450 x D40	14.1
TFS100180 - Temporary Mesh Fencing Extension Panel	H400 x W3450 x D40	8

*The 2m Std Temporary Mesh fencing is not anti-climb



Fence Covers

Colour Options:

Cover your mesh fence panels to increase privacy and minimise dust and rubbish entering or leaving the site.

Description	Size (mm)	Sheet Quality (gsm)
TFS101000 - Std Scaffold Sheeting Roll	H2000 x W45000	170
TFS101010 - Std Scaffold Sheet Flame Retardant Roll	H2000 x W45000	170
TFS101020 - Prem Scaffold Sheet Flame Retardant Roll	H2000 x W45000	240
TFS101030 - HD Vented Sheet Flame Retardant	H2000 x W45000	100
TFS101100 - Debris Netting	H2000 x W50000	40
TFS101180 - PVC Mesh Temporary Fence Cover	H1750 x W3370	300



For further information on specific noise reduction details from these acoustic barriers, contact our sales team at info@safesitefacilities.co.uk

SafeSite's innovative acoustic solution addresses the challenge of environmental noise pollution arising from demolition, construction sites, and roadworks.

Description	Size (mm)	Weight (kg)
TFS101235 Acoustic Barrier 1.2m	H2000 x W1200 x D20	4.8
TFS101240 Acoustic Barrier 3.5m	H2000 x W3550 x D20	12



Minimise noise pollution in city centre locations, or during heavy duty works with our acoustic barriers which cloak your mesh fence panels.

Description	Size (mm)	Weight (kg)
TFS101210 - Echo Acoustic Barrier H4	H2050 x W1335	6.8
TFS101220 - Echo Acoustic Barrier H8	H2050 x W3650	9
TFS101222 - Echo Acoustic Barrier H9	H2050 x W1335	5.3

Providing a full and cost-effective solution for temporary fencing at your site, including surveys, engineering, installation, and aftercare, all covered in one price.

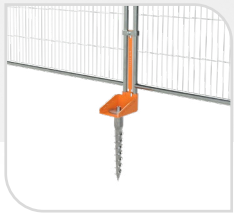

Set A – Open Mesh System



Set B – Open Mesh with Stabilising Brace System

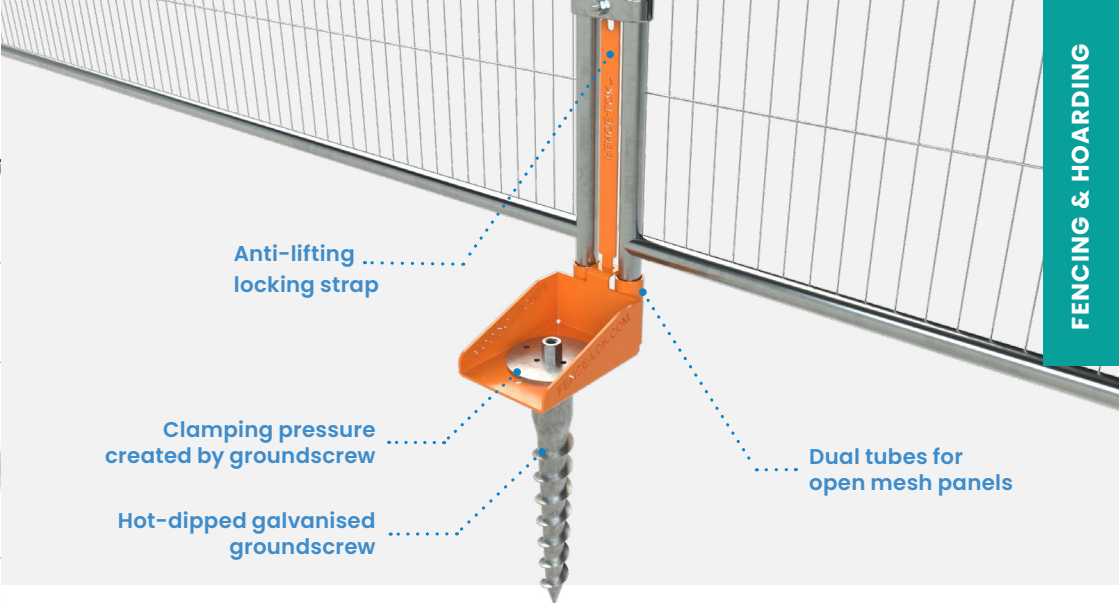

Customer journey

- 1 **Site Visit, Measure Perimeter and Load Test**
 - Free site survey to measure perimeter.
 - Free on-site soil, concrete, and asphalt load testing.
 - Temporary Works designs that comply with BS5975 for any site.
- 2 **Temporary Work Design & Check**
 - Full Design Works & Check Certificate with calculation.
 - Design wind load calculation.
 - Preliminary Temporary works calculation based on soil load test.
 - Can be used with signage and branding
- 3 **Supply Specified System**
 - Nationwide delivery and installation services.
 - Different fixing options. System can be installed on soil, grass, concrete, or asphalt surfaces.
- 4 **Full Installation & Optional GPR Survey**
 - The System's Ground Screws can quickly be installed using a readily available petrol-driven or battery impact driver.
 - Free On-site training and support.
 - Cat scan as standard. GPR available if required.
- 5 **Removal & Transfer To Next Site**
 - As simple to uninstall as it is to set up.
 - Constructed from robust, rust-resistant metal materials.
 - Relocate and reuse multiple times.

Fixing Options	Depth (mm)	Qty Per Bracket
----------------	------------	-----------------



Soil Fixing Ground Screw	500	1
--------------------------	-----	---

Concrete Fixing Screw	100	2
-----------------------	-----	---

Asphalt anchor fixings	100	2
------------------------	-----	---

Hoarding

There are a range of materials and installation options for hoarding. We offer UPVC, timber and steel systems which can be installed into, or on top of the ground.



Colour Options: 

Free standing timber hoarding provides a secure perimeter around sites. It is an ideal option when it's not possible or appropriate to install 'in-ground hoarding'.

At SafeSite Facilities, we install the hoarding using above-ground support and ballast to achieve the same level of privacy, security and integrity as in-ground hoarding.

We recognise that every site is different, which is why you have the option to customise or brand your timber hoarding. Our customisation options include the thickness of timber and the colour or finish. We also custom-cut our timber to fit the exact size and shape of your perimeter.



Colour Options: 

A dug-in foundation for your timber hoarding ensures that the perimeter stays standing in most weather conditions. We only use FSC timber and can be installed anywhere in the UK.



Colour Options: 

Made from 50% recyclable material - The UPVC hoarding can be used for any sort of terrain. Easy to install with no excavation needed.

Colour Options: 

Our steel hoarding has a quick and simple installation process, which means it is perfect for short to medium term projects. It is available in our standard grey, white and black powder coated finish, but we can also provide any colour at your request.



Temporary Hoarding Panel

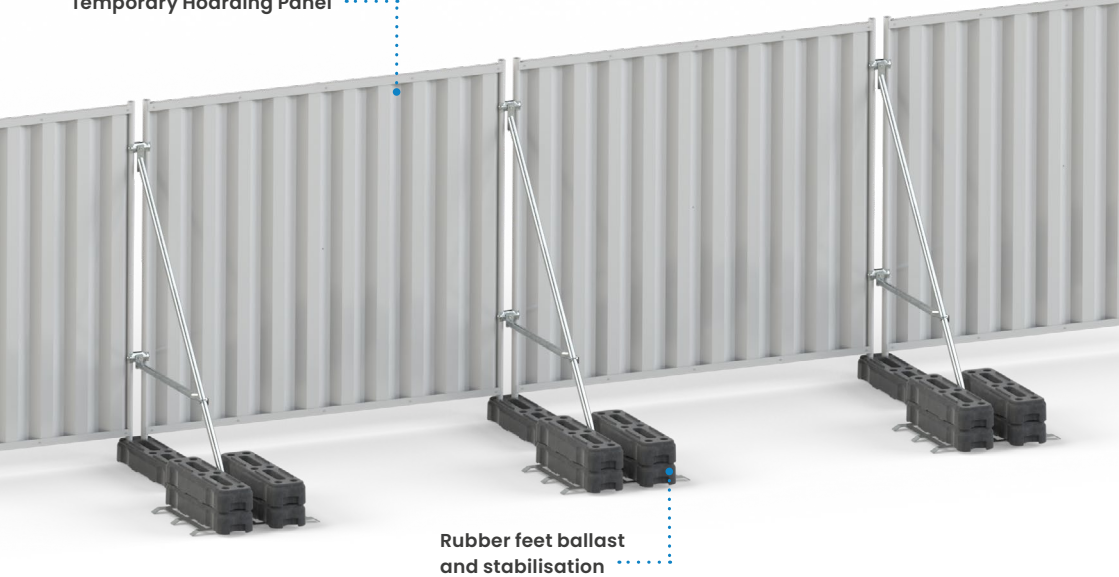

Rubber feet ballast and stabilisation

Description	Size (mm)	Weight (kg)
THS110050- 2m Temporary Hoarding Panel	H1980 x W2140 x D40	30
THS110200 - 2.4m Temporary Hoarding Panel	H2380 x W2140 x D40	40
THS110350 - 2m Infill Panel	H1710 x W140 x D15	2.38
THS110400 - 2.4m Infill Panel	H2110 x W140 x D15	2.94

Colour Options: 

Steel hoarding panels sit flush with the floor and use a tray for holding ballast. The system is ideal for projects where high levels of privacy are required. The block and tray system means that there is a greater capability for holding ballast and increasing wind resistance.

In / On Ground Hoarding Panel

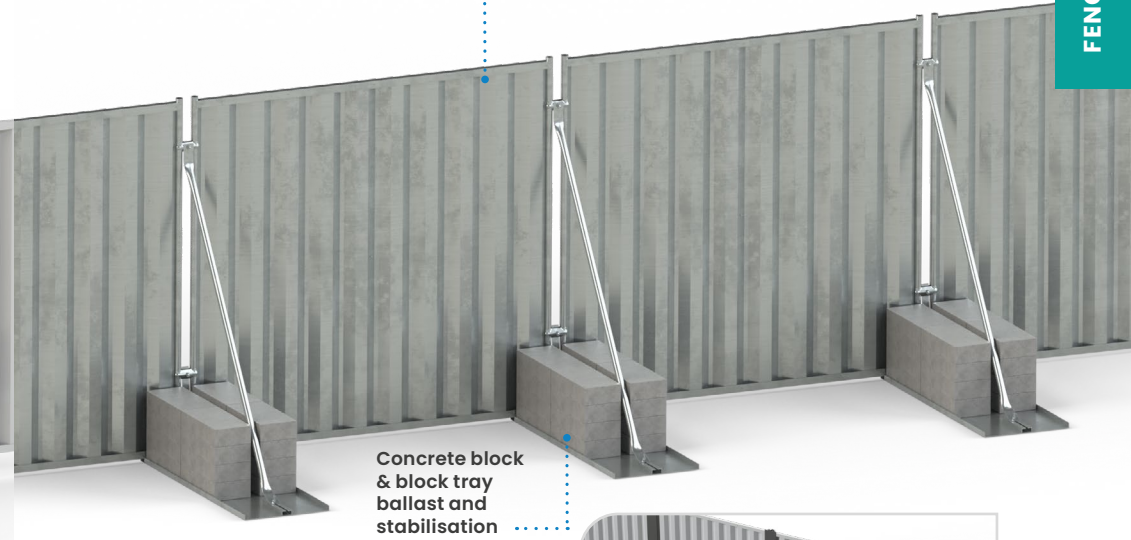

Concrete block & block tray ballast and stabilisation

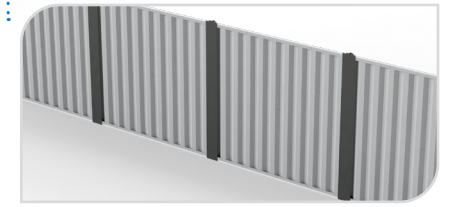

We also provide an **In Ground Hoarding** Option. Contact our sales team for more info.

Description	Size (mm)	Weight (kg)
THS111050 - 2m In/On Ground Temporary Hoarding Panel	H2000 x W2100 x D43	30
THS111100 - 2.4m In/On Ground Temporary Hoarding Panel	H2400 x W2100 x D43	40
THS111350 - 2m Infill Panel	H1910 x W140 x D15	2.66
THS111400 - 2.4m Infill Panel	H2310 x W140 x D15	3.22

Temporary Gates

Colour Options: 

Vehicle and pedestrian gates are available for use with temporary mesh and hoarding systems. We offer a range of sizes and finishes including galvanised and powder-coated in a range of colours.

Mesh Gates

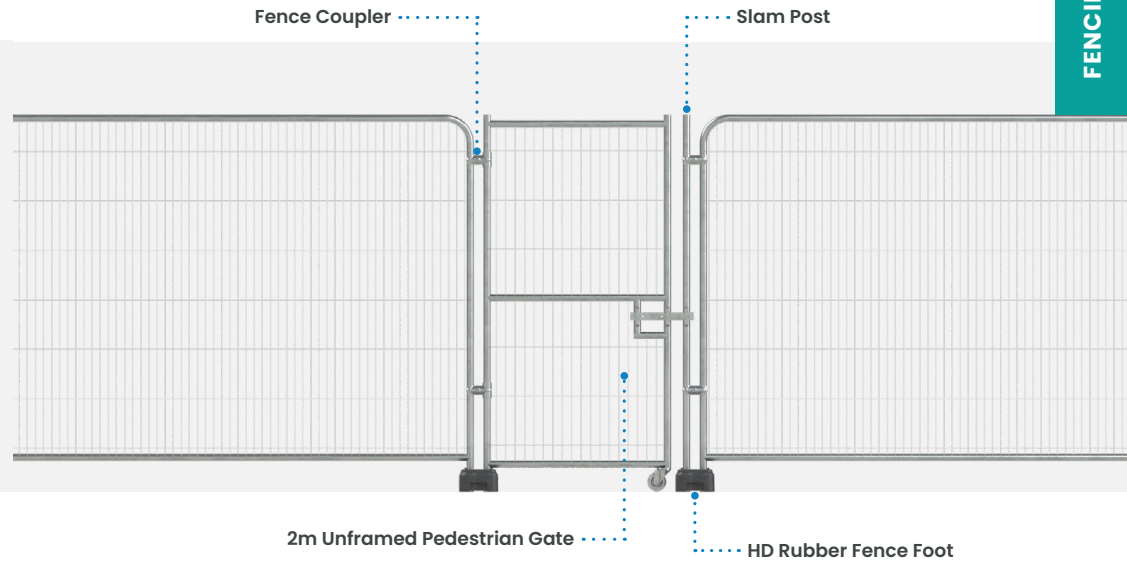
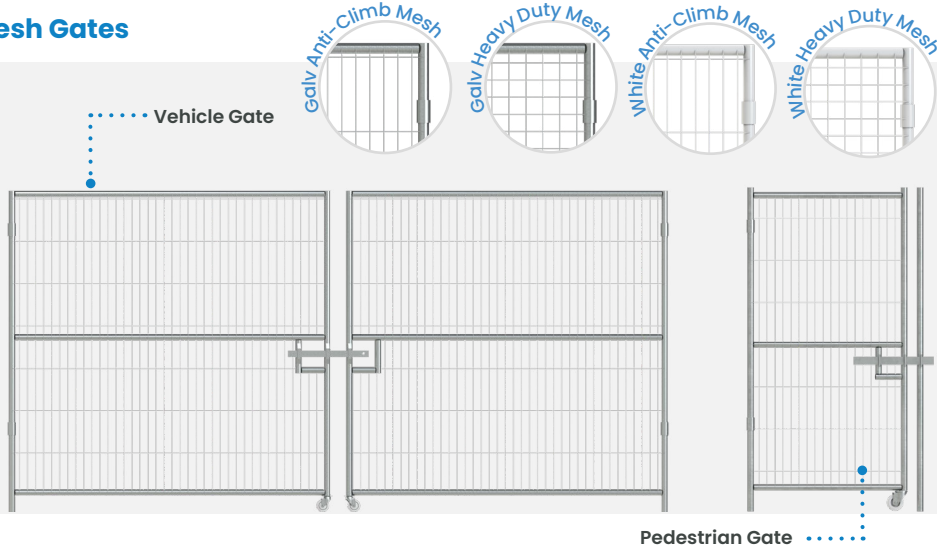

	2m High Galv	2m High White	2.25m High Galv	2.25m High White	2.4m High Galv	2.4m High White
4m Wide Vehicle Gate	✓	✓	-	✓	✓	-
5m Wide Vehicle Gate	✓	✓	-	✓	-	-
6m Wide Vehicle Gate	✓	✓	-	✓	-	-
7m Wide Vehicle Gate	✓	✓	-	✓	-	-
Unframed Ped Gate	✓	✓	-	✓	-	-
Framed Ped Gate	✓	✓	-	✓	-	-

The above table is our standard mesh gate options that we provide. We can manufacture bespoke sizes and colour options on request. Our sales team will help assist on this along with correct components and adaption panels required. Please contact us for more information and your requirements at info@safesitefacilities.co.uk

Colour Options: 

This is a heavy duty framed gate which needs only feet and couplers to attach to your fence or hoarding system. The gate features a digital lock for additional security.

Example of Digi Lock Gate in situ

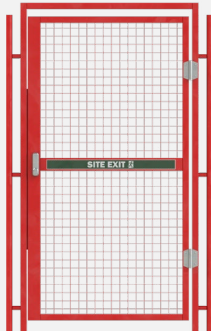

Description	Size (mm)	Weight (kg)
THS112620 Heavy Duty Pedestrian Digi Lock Gate	H2080 x W1282 x D38	72

Hoarding Gates

Colour Options:

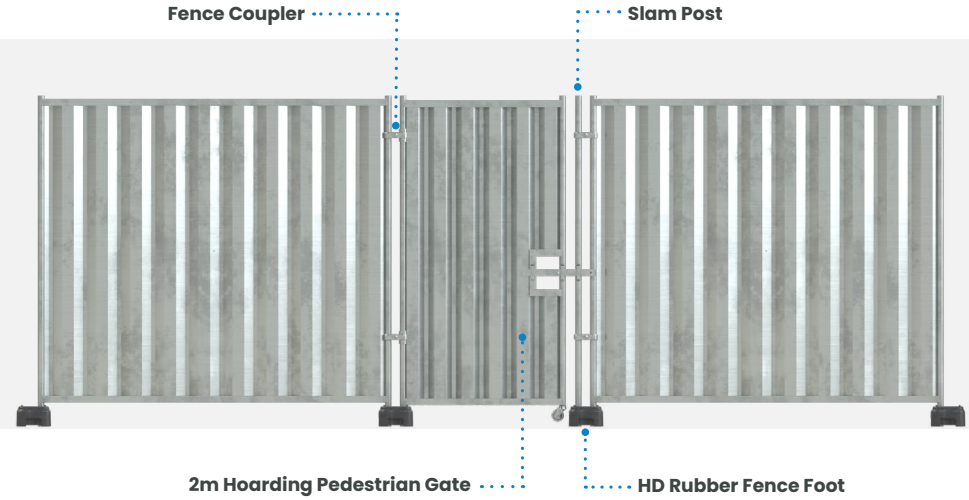
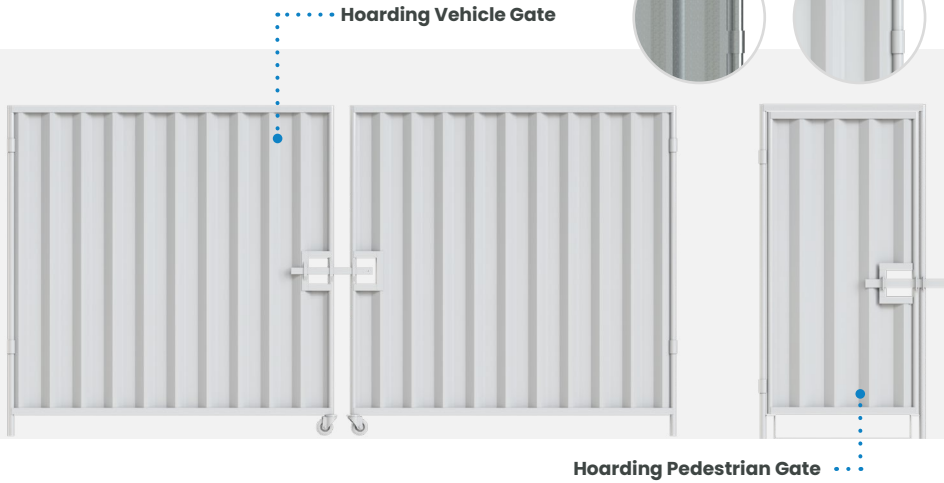

	2m High Galv	2m High White	2.25m High Galv	2.25m High White	2.4m High Galv	2.4m High White
4m Wide Vehicle Gate	✓	✓	-	✓	✓	-
5m Wide Vehicle Gate	✓	✓	-	✓	✓	-
6m Wide Vehicle Gate	✓	✓	-	✓	✓	-
7m Wide Vehicle Gate	✓	✓	-	✓	✓	-
Unframed Ped Gate	✓	✓	-	✓	✓	-
Framed Ped Gate	✓	✓	-	✓	✓	-

The above table is our standard hoarding gate options that we provide. We can manufacture bespoke sizes and colour options on request. Our sales team will help assist on this along with correct components and adaption panels required. Please contact us for more information and your requirements at info@safesitefacilities.co.uk

HERE TO HELP

It can be difficult to understand the different types of fence panels, hoarding and gates. Add to that the attention that needs to be paid to stabilisation and ballast, you can find yourself tied up in knots.

Our experienced sales teams can talk you through your options, organise a site inspection and provide a free no obligation quote. Contact us today to learn more!

Contact our sales team at info@safesitefacilities.co.uk or call **0800 012 5457**

High Security Fencing

Colour Options: 

Permanent fencing which is installed into the ground is known as 'high security fencing'. Each type of fencing offers varying degrees of protection and can be used with a choice of add-ons, such as anti-climb spinners.

Chain link mesh fencing is manufactured from galvanised steel and comes in various sizes and dimensions.

The system is comprised of posts, pales and fittings and made from high quality steel.



Anti-Climb Spinners

Adding anti-climb rotator spikes to your fencing system will deter even the most ambitious intruders.

We sell, supply, and install high security fencing fence systems and gates.

For more information on your custom fencing needs please contact us for your bespoke high security fencing enquiries at info@safesitefacilities.co.uk

Edge Protection

Edge protection is essential for elevated areas within a site to prevent persons or machinery falling from height. These barriers are made from high quality steel and both the posts and mesh can be customised to any RAL colour.



Once correctly installed the Edge Protection Barrier can withstand up to a tonne of lateral force, more than enough to prevent personnel and light machinery toppling over a high ledge.

Description	Size (mm)	Weight (kg)
EGS250000 - Edge Protection Barrier 2.6m	H1150 x W2600 x D200	16.2
EGS250010 - Edge Protection Barrier 1.3m	H1150 x W1300 x D200	8.5

Timber fencing is an affordable, strong and aesthetically pleasing way to provide security and privacy for your property. We stock numerous styles of timber fencing to suit all needs and can offer timber, concrete and metal posts, depending on your requirements.

Typically used as a boundary for residential areas, vertical feather edge boards overlap to create a seamless, wood boundary.

Wooden posts and panels are a tried, tested, and effective way to create a uniform and professional boundary.

A popular option for use on farmland perimeters, post and rail fencing is straightforward to install and very effective in keeping large livestock contained.

These are created for bespoke purposes. Please contact our sales team for your enquiries at info@safesitefacilities.co.uk



I purchased several panels of security fencing for a new build property. It's a nice product at a good price and was delivered very quickly with no hassle.



S. B.

safesite[®]
F A C I L I T I E S

Water Filled Barriers - Temporary Fencing, Hoarding & Gates

We have put together some examples of our water filled barriers with mesh, hoarding and gates. This should give a visual representation of what our barriers look like with fencing and what options we have for each system.

Bison Barrier

Std Anti-Climb Mesh Fencing Heavy Duty Mesh Fencing Hoarding Panels

Pedestrian Gate Vehicle Gate

Hoarding Gates Available

Bison 800 Barrier

Std Anti-Climb Mesh Fencing 2m Anti-Climb Mesh Fencing Heavy Duty Mesh Fencing Std Hoarding Panels 2m Hoarding Panels

Pedestrian Gate Vehicle Gate

Hoarding Gates Available

Mini Bison Barrier

Anti-Climb Mesh Fence Panel

RB2000 Barrier

Anti-Climb Mesh Fencing Hoarding Panel Hoarding & Mesh Panel

Pedestrian Gate Vehicle Gate

Hoarding Gates Available

Novus Barrier

Anti-Climb Mesh Fencing

Pedestrian Gate Vehicle Gate

RB22 Barrier

Anti-Climb Fencing Heavy Duty Fencing Hoarding Panel Hoarding & Mesh Panel

Pedestrian Gate Vehicle Gate

Hoarding Gates Available

GB2 Barrier

Anti-Climb Fencing Heavy Duty Fencing Hoarding Panel Hoarding & Mesh Panel

Pedestrian Gate Vehicle Gate

Hoarding Gates Available

Pyramid Barrier

Mesh Panel Hi-Vis Mesh Panel

Euro Barrier

Euro Barrier Mesh Panel Euro Barrier Hi-Vis Mesh Panel Euro Barrier Hi-Vis Post & Plank Euro 2 Barrier Mesh Panel Euro 2 Barrier Hi-Vis Post & Plank

Evo Barrier

Evo 55 Barrier Mesh Panel Evo 55 Barrier Hi-Vis Mesh Panel Evo 500 Barrier Mesh Panel Evo 500 Barrier Hi-Vis Mesh Panel Evo 1.5 Barrier Mesh Panel Evo 1.5 Barrier Hi-Vis Mesh Panel

Evo 80 Barrier Mesh Panel Evo 80 Barrier Hi-Vis Mesh Panel

Street Work Barriers - Temporary Fencing, Hoarding & Gates

We have put together some examples of our street work barriers with mesh, hoarding and gates. This should give a visual representation of what our barriers look like with fencing and what options we have for each system.

Manta Barrier

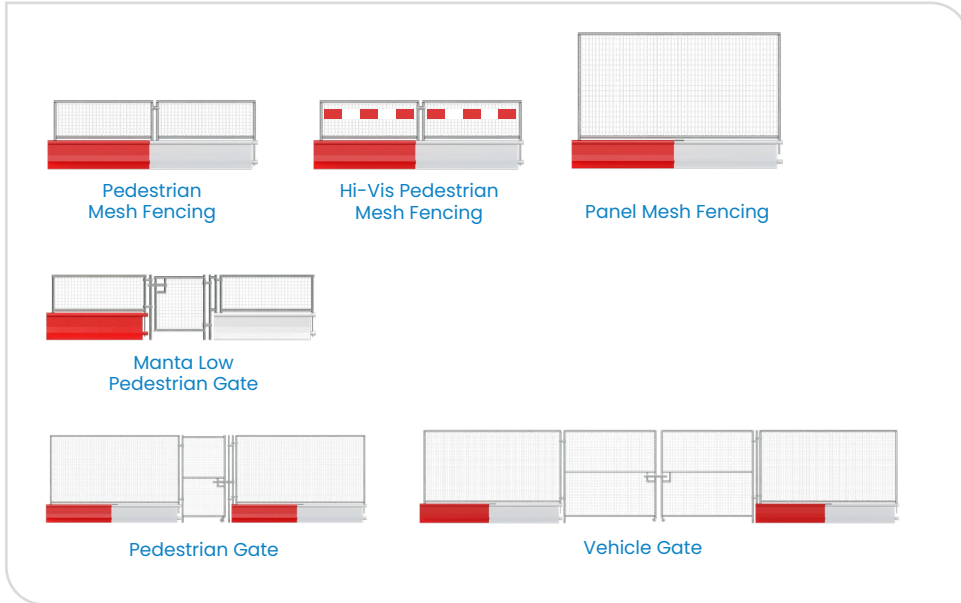

Bull Barrier

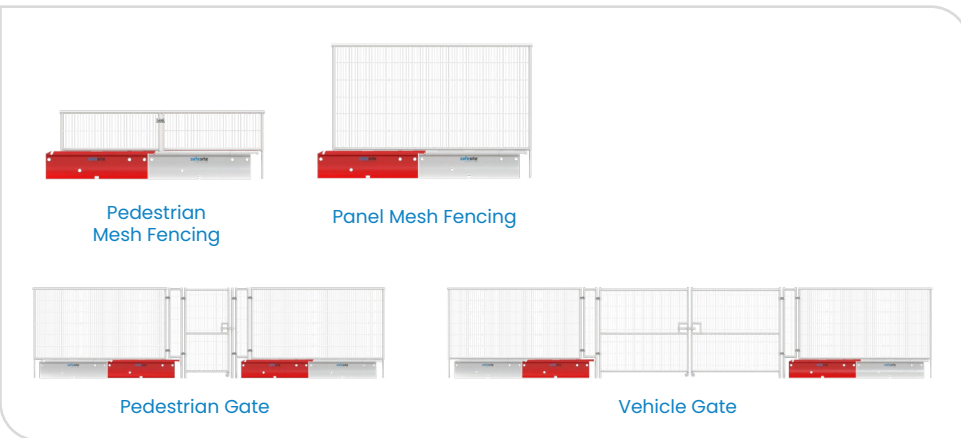

Mass Barrier

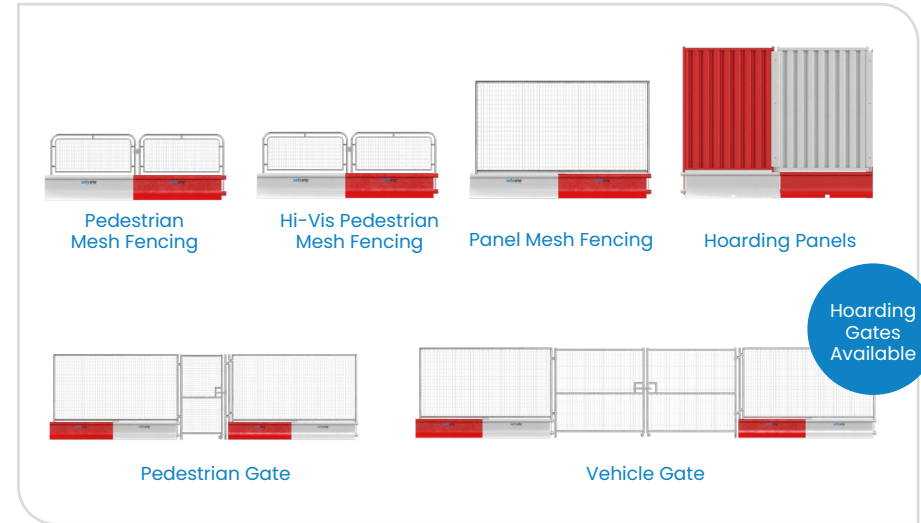

Fencing & Hoarding Accessories

We offer a number of accessories appropriate for use with fencing and hoarding.



Std Fence Coupler

TFS100500 - Gripper
Size: H26 x W136 x D78mm
21mm Socket needed or
TFS101600/610



HD/Z Gripper Fence Coupler

TFS100520
Size: H35 x W140 x D55mm
21mm Socket needed or
TFS101600/610



Large Fence Coupler HWT

TFS100540
Size: H35 x W170 x D50mm
TFS100515 Std Spanner with
20mm Socket needed



Fence Light

TFS100550
Fence Light Coupler



Anti Tamper Coupler

TFS100510
Size: H35 x W130 x D50mm
Silver/Gold Spanner needed



HD/Z Anti Tamper Gripper Fence Coupler V1 Silver

TFS101620 - ZND Silver
V1 Gold Spanner needed



HD/Z Anti Tamper Gripper Fence Coupler V2 Gold

TFS100530 - ZND Gold
V2 Silver Spanner needed



Anti Tamper Fence Spanner Silver/Gold

TFS100517 - Silver/Gold
Size: H30 x W290 x D30mm



HD/Z Anti Tamper Fence Spanner V1

TFS101600 - V1 Gold
Size: H30 x W290 x D30mm



HD/Z Anti Tamper Fence Spanner V2 Silver

TFS101610 - V2 Silver
Size: H30 x W290 x D30mm



MonoLight LED

STS211800
MonoLight LED



Reflective Fence Strip

MIS300003
2m Red & White
Size: W2000 x D140mm

MIS300005
3.5m Red & White
Size: W3500 x D160mm

Colour Options:



Battery Hoarding Light

STS211860
Bulkhead Battery
Hoarding Light

STS211875
Bulkhead Light
Hoarding Bracket

STILLAGES

CUSTOM-MADE TO ORDER



Stillages provide a compact, safe and secure method for storing or transporting products. We can custom manufacture stillages to your size and requirements.

Contact a member of the sales team on info@safesitefacilities.co.uk for more information.

BALLAST & STABILISATION

We offer a wide range of products to assist in the stability and security of your barriers, fencing and hoarding. Choose from an array of reliable and sustainable options increasing the wind resistance and resilience of your perimeter protection.



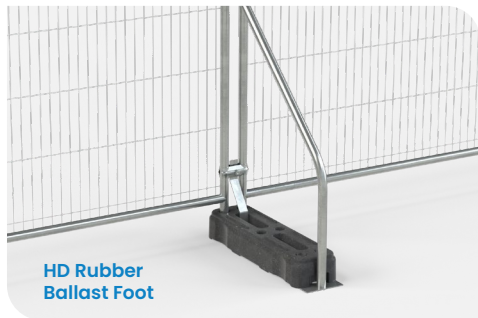

Colour Options: ● ● ●

This sand filled ballast bag offers a quick, durable, fuss-free solution for improving the wind resistance of your pedestrian barriers. Ballast bags are ideal for locations where there are large numbers of pedestrians such as high streets and events.

Description	Size (mm)	Weight (kg)
PBS130455 Ballast Bag	H150 x W500 x D160	10

The sleek, compact design neatly drops onto the lower rail of a pedestrian barrier and features high visibility inserts to ensure visibility in poor weather and light.

Description	Size (mm)	Weight (kg)
PBS130470 Ballast Drop Blocks	H395 x W250 x D98	9

These environmentally friendly feet are manufactured from recycled PVC and are used as ground supports for our temporary fencing and hoarding panels.

Description	Size (mm)	Weight (kg)
TFS100600 Rubber Foot	H115 x W750 x D200	15
TFS100610 HD Hi-Vis Rubber Foot	H115 x W750 x D200	15

Stackable rubber ballast blocks are made from recycled materials and can be used as a fence foot or ballast. Each block weighs 20kg and can be stacked neatly to quickly increase the wind resistance of any fence system.

Description	Size (mm)	Weight (kg)
TFS100708 Rubber Ballast Block	H210 x W520 x D260	20

These are made from UV resilient MDPE and filled with concrete. The plastic shell ensures that the block is very visible and durable in all weather conditions.

Description	Size (mm)	Weight (kg)
TFS100730 Hi-Vis Concrete Ballast Block	H295 x W609 x D300	44

Colour Options: ● ○

The road rock is a multi-functional base that can add stability to barriers and fencing. It is made from 100% recycled material and features a handle for easy lift up.

Description	Size (mm)	Weight (kg)
SBS200350 – Road Rock	H308 x W500 x D315	15

Rota Block Minis with temporary fencing

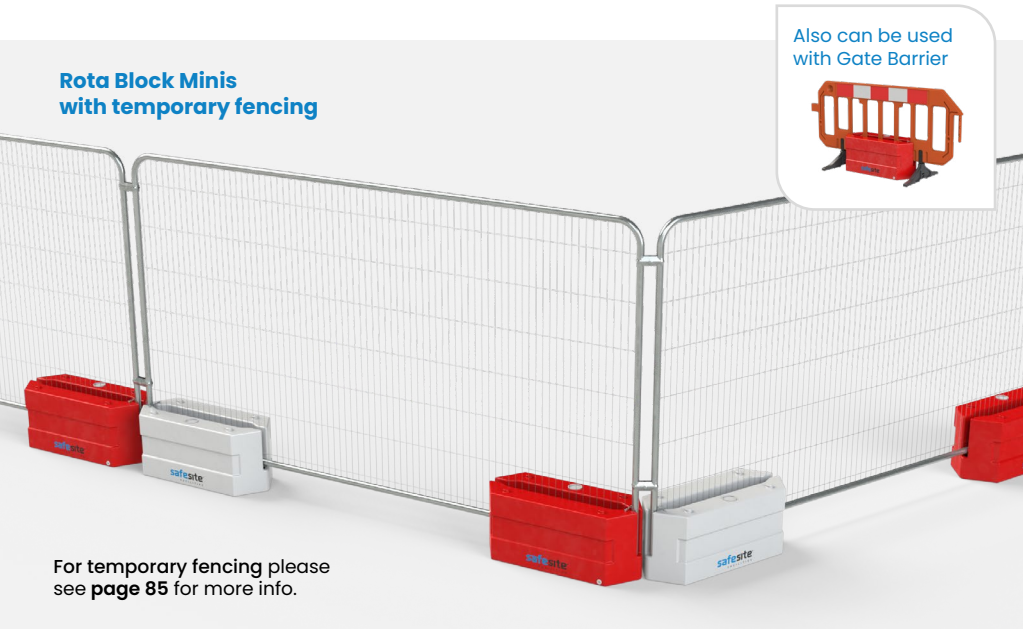

For temporary fencing please see [page 85](#) for more info.

Colour Options: ● ● ● ● ●

This water filled block is designed to work in lines and around corners. It provides a simple way to hold mesh panels in place, negating the need for rubber feet. This block can also be used to secure gate barriers in place.

Description	Size (mm)	Weight (kg)	Weight Filled (kg)
WFS151130 – Rota Block Mini	H400 x W1000 x D390	8.9	105
WFS151150 – Rota Block Security Chain	-	-	-

The Rota Block is an alternative approach of installing temporary fencing and hoarding at your site, utilising water filled containers instead of traditional ballast.

WT

Description	Size (mm)	Weight (kg)	Weight Filled (kg)
WFS151160 – Rota Block	H985 x W720 x D605	22	333



For temporary hoarding please see [page 92](#) for more info



Std Stabiliser
 TFS100740
 Size: W1487 x D45mm
 Weight: 3.2kg



Short Stabiliser
 TFS100780
 Size: H40 x W1028 x D678mm
 Weight: 1.75kg



Grid Ballast Tray
 TFS100750
 Size: W780 x D510mm



Cross Brace
 TFS100770
 Size: H126 x W788 x D75mm
 Weight: 1.45kg



Stabiliser 2/2.4m
 TFS111700 - Stabiliser 2m
 Size: W2150 x D40mm
 Weight: 3.2kg

 TFS111710 - Stabiliser 2.4m
 Size: W2280 x D40mm
 Weight: 3.2kg



Angled Stabiliser
 TFS100700
 Size: W1200 x D680mm
 Weight: 2.9kg



Heavy Duty Block Tray
 TFS111720
 Size: H500 x W1300 x D500mm



Ballast Block
 TFS100706
 Size: H100 x W440 x D215 mm
 Weight: 18kg



Ground Pins
 TFS100900
 Std Ground /Stabiliser Pin

 TFS100910
 HD Ground/Stabiliser Pin



Anti-Lift Bracket
 TFS100930
 Size: H345 x W165 x D40mm
 Weight: 0.4kg





HERE TO HELP

It can be difficult to understand the different types of fence panels, hoarding and gates. Add to that the attention that needs to be paid to stabilisation and ballast, you can find yourself tied up in knots.

Our experienced sales teams can talk you through your options, organise a site inspection and provide a free no obligation quote. Contact us today to learn more!

Contact our sales team at info@safesitefacilities.co.uk or call 0800 012 5457

CCTV and alarms are integral to ensuring that a site is safe and secure. We offer mains, battery and solar powered CCTV & alarms that are monitored 24/7. Our solutions feature advanced AI technology which reduce false alarms and increase detection accuracy.

Safety can also be enhanced with the use of access control turnstiles as well as fire safety products to give sites full protection.





Battery Powered

Powered by batteries for up to a year



Wireless Alarms

We offer completely wireless battery powered alarms with visually verified high-definition images. The system uses advanced AI capability to accurately detect and deter intruders with automatic sirens and speakers.

Features



AI (Artificial Intelligence)

Advanced AI detection to filter out false alarms



24/7 Monitored Alarms

Full monitoring of alarms by our monitoring station



Sirens

Loud sirens to automatically deter intruders



Full 4G Connectivity

4G internet with a mobile app for live view and playback



Options for Power

Mains, generator or solar powered (3-4 day battery backup)

Rapid deployment mobile CCTV towers provide the ultimate visual deterrent against intruders. Deployable virtually anywhere, with or without power, your site will be protected by advanced AI cameras on a 5-6m mast.

Features



HD Cameras

4 x HD cameras (360 degree view) with 24hour recording



24/7 Monitored Alarms

Full monitoring of alarms by our monitoring station



Audio Announcements

Loud speaker to deter intruders



Full 4G Connectivity

4G internet with a mobile app for live view and playback



Temporary CCTV

Combining a traditional cabled CCTV system with advanced AI technology gives maximum coverage and protection for your site. You can watch the high definition cameras from a local monitor giving you full site visibility, with the peace of mind we will monitor your site when you're not there.

Features



HD Cameras

High definition cameras with 24hour recording

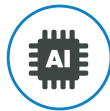

AI (Artificial Intelligence)

Advanced AI detection to filter out false alarms



Monitoring Station

Full monitoring of alarms by our monitoring station



Audio Announcements

Loud speaker to deter intruders



Full 4G Connectivity

4G internet with a mobile app for live view and playback



Timelapse

Record the whole duration of your project with a panoramic high definition camera. Showcase your full project into a few minutes with your chosen music and your own branding. Follow the evolution of your project with up to the minute images available through our secure online portal.

Features



Solar Power

Completely solar powered (or 12v power option)



Backup

Secure cloud image backup



Compact Design

Cable-free design means it can be mounted virtually anywhere



Versatility

Ideal for construction, demolition or events

Access Control

We offer temporary access control solutions to keep sites safe and secure.



Turnstiles

Monitor and control anyone who enters your site with an access control turnstile from Safesite Facilities. Multiple size options available from half height to full height turnstiles for maximum site security. The turnstiles can be integrated with the fire alarm system to automatically open in the event of a fire.

Features

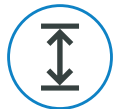

Height Options

Half and full height turnstile options



Access Control

Block access to certain users



CSCS Card Checks

Construction Skills Certification Scheme



Audit

Full audit log of every entry exit



Fire Alarm Integration

Automatic opening on fire alarm



Fire Protection

Protect people and property from the risks of fire with our range of temporary fire equipment. Built for the construction and event industry, all devices use long distance wireless technology to communicate. Low power consumption gives you industry leading battery life for less maintenance visits.



Smoke & Heat Alarms

The SafeSite fire / heat detectors can be wirelessly located around your site to detect fires. Integrated sounders create an 85dB alarm so separate sirens are not needed.



Manual Fire Call Point

The fire call points are wireless and can be located at key areas around your site. On the discovery of a fire, people can press the manual call point which will sound the alarm to all other devices on the network.



Fire Extinguishers & Trolleys

The manual fire call points can be integrated with our Fire Extinguisher trolley, which can be fitted with the appropriate extinguishers.



We also provide **Fire Risk Assessments** on your premises for your safety needs!

Index

3Sixty Bollard	61	EnduraMat	78	Mass Barrier	45	Smoke & Heat Alarms	125
Acoustic Barriers	87	Euro Barrier	22	Mesh Gates	94	Speed Ramp	56
Additional Items	63	Evo Barriers	23	Mirus Barrier	46	Steel Road Plates	74
Anti-Climb Spinners	98	Fence Covers	86	Novus Barrier	13	StrongWall Barrier	50
Automatic Arm Barrier	68	Fence-Lok System	88	On Ground Hoarding	93	Supa-Trac	76
Avalon Barrier	48	Fire Extinguishers & Trolleys	125	Overhead Guardian		Temporary CCTV	122
Ballast Bag	112	Firmus Barrier	48	Goal Post	60	Temporary Hoarding	92
Ballast Drop Blocks	113	Fixed Leg Pedestrian Barrier	34	Palisade Security Fencing	98	Temporary Mesh Fencing	85
Baulk Timber	53	Flexible Traffic Posts	61	Police Pedestrian Barrier	34	TerraGuard™	76
Bell Bollard	60	Flood Barrier 500mm	25	Post and Panel Fencing	100	Thor Barrier	53
Bison 800 Barrier	12	Flood Barrier 900mm	25	Post and Rail Fencing	100	Timber Hoarding	90
Bison Barrier	10	Free-Standing	90	Postman Barrier	53	Timelapse	123
Bison Mini Barrier	12	Gate Barrier	47	Pyramid Barrier	22	Titan Barrier	48
Boss Barrier	47	GB2 Barrier	16	RB22 Barrier	14	Titan Expandable Barrier	37
Buddha Barrier	19	Ground Guard MultiTrack Mat	79	RB2000 Barrier	11	Traffic Cones	63
Bull Barrier	44	GRP Safety Grating	80	RB Track Safety Barriers	24	TrafficLine Kerb	59
Cable/Hose Protection Ramp	58	Hardwood Bog Mat	79	Retractable Belt Barrier	37	Traffic Log	46
CCTV Tower	121	HD Rubber Ballast Foot	113	Road Form	57	Turnstiles	124
Centipede Barrier	37	Heavy Duty Ped Digi Lock Gate	95	Road Rock	114	Temporary Vertical Concrete Barrier	29
Centipede II Barrier	36	Heavy Duty Road Plate	75	Road Runner	46	UPVC Hoarding	91
Chain Fencing	98	Height Restrictor	68	Rota Block	115	Vee Block	31
CityWall Barrier	18	Hi-Vis Concrete Ballast Block	113	Rota Block Mini	114	V-Fence Barrier	52
Clear Path Mat	78	Hoarding Gates	96	Rota Slot	21	Walkthrough Pedestrian Barrier	35
Closeboard Wooden Fencing	100	Hog-600 Barrier	20	Rubber Ballast Block	113	Wheel Stop Kit	70
Column/Pillar Protection	61	Illuminated Walkway	38	Safe Cover	77	Wireless Alarms	120
Concord Pedestrian Barrier	34	Jersey Interlocking Barrier	31	SafeGate Barrier	52	WonderWall Barrier	51
Concrete Barrier	30	Legato Block	28	Safe Kerb Ramp	59	X-ECO Mobile Lighting Tower	64
Costumer journey	89	Loose Leg Pedestrian Barrier	34	Safe Kerb SupaGrip Ramp	59		
Dug-In Timber Hoarding	91	LowPro	77	SafeMat	78		
Duo Kentledge Block	30	Manta Barrier	42	Safe Walk Matting	79		
Echo Acoustic Barriers	87	Manual Arm Barrier	69	Security Bollards	69		
Edge Protection Barrier	99	Manual Fire Call Point	125	Skipper	63		
EnduraGrid	78	Marquee Blocks	31	Slot Block Barrier	20		



Plenty of help with ordering exactly what we required for site. Fast quotation service and assistance in setting up an account. Best price around. Speedy delivery.



B. H.

safesite[®]
FACILITIES

SafeSite Security Solutions provide all the services you need to keep your property safe and secure.

Services we provide:

- > **Site perimeter protection**

> **Specialist clearance and cleaning**
- > **Building access prevention**

> **Alarms and CCTV surveillance**

Some of our reviews

“ *Excellent staff, so very helpful amazing clearance - Paula* ”

“ *From quoting to installation the service has been fantastic and very efficient - Jamie* ”

“ *Seamless from initial enquiry to attending site and making our clients property secure. Very efficient and so much help - Turnpower* ”



NATIONWIDE DELIVERY



Call us now
0800 012 5457

Northern
depot

Midlands
depot

Southern
depot

We have fleet of vehicles that can deliver from our Northern, Midlands and Southern depots, anywhere across the UK and into Europe.

VISIT



OUR WEBSITE

You can find more information on our products, where you can order or hire them for your construction needs.



